



National Aeronautics and
Space Administration

Langley Research Center
Hampton, VA 23681-2199

Educational Product	
Educators	Grades 3-5

EG-2002-10-13-LARC

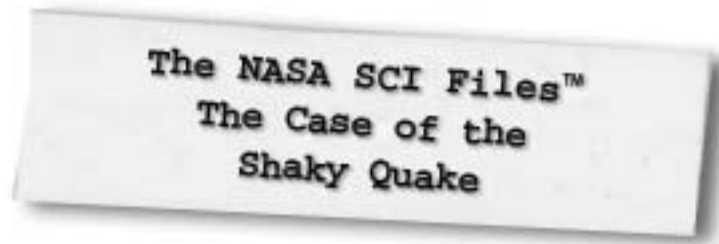

**A Lesson Guide with Activities in
Mathematics, Science, and Technology**

Please Note: Our name has changed! The NASA "Why" Files is now the NASA Science Files™ and is also known as the NASA SCI Files™.



The Case of the Shaky Quake lesson guide is available in electronic format through NASA Spacelink - one of NASA's electronic resources specifically developed for the educational community. This publication and other educational products may be accessed at the following address: <http://spacelink.nasa.gov/products>

A PDF version of the lesson guide for NASA SCI Files™ can be found at the NASA SCI Files™ web site: <http://scifiles.larc.nasa.gov>

The NASA Science Files™ is produced by the NASA Center for Distance Learning, a component of the Office of Education at NASA's Langley Research Center, Hampton, VA. The NASA Center for Distance Learning is operated under cooperative agreement NCC-1-02039 with Christopher Newport University, Newport News, VA. Use of trade names does not imply endorsement by NASA.



www.swe.org



www.buschgardens.com



www.cnu.edu



www.epals.com



www.sbo.hampton.k12.va.us



<http://quest.arc.nasa.gov>



www.nec.com

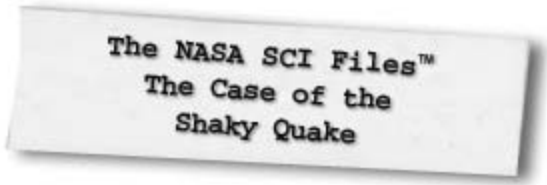

A Lesson Guide with Activities in Mathematics, Science, and Technology

Program Overview5
 National Science Standards6
 National Mathematics Standards.....8
 National Technology Standards.....10
 National Geography Standards12

Segment 1

Overview13
 Objectives14
 Vocabulary14
 Video Component.....15
 Careers.....15
 Resources16
 Activities and Worksheets17

Segment 2

Overview27
 Objectives28
 Vocabulary28
 Video Component.....28
 Careers.....29
 Resources30
 Activities and Worksheets31

Segment 3

Overview39
 Objectives40
 Vocabulary40
 Video Component.....40
 Careers.....41
 Resources42
 Activities and Worksheets42

Segment 4

Overview51
 Objectives52
 Vocabulary52
 Video Component.....52
 Resources53
 Careers.....53
 Activities and Worksheets54

For additional information about the NASA SCI Files™, contact Shannon Ricles at (757) 864-5044 or s.s.ricles@larc.nasa.gov.

Production of the NASA SCI Files™ is made possible by the generous support provided by the Society of Women Engineers (SWE); Busch Gardens, Williamsburg; Hampton City Public Schools; and the NASA Langley Research Center’s Learning Technology Project and Aerospace Vehicle Systems Technology Program Office.

Writer and Teacher Advisors: Shannon Ricles, Dan Green, Mike Young, and Tim Hatok

Editor: Susan Hurd



Registered users of the NASA SCI Files™ may request a Society of Women Engineers (SWE) classroom mentor. For more information or to request a mentor, e-mail kim.tholen@swe.org



Captioning provided by NEC Foundation of America



Program Overview

One afternoon, the tree house detectives feel their tree house shake. They wonder what could have caused the vibration. Unsure whether they had just experienced an earthquake, the tree house detectives decide to make the unexplained vibration the subject of their next case and set out to solve *The Case of the Shaky Quake*.

To solve this mystery, the detectives decide that a seismologist will know the answer, but they quickly learn that it is not that simple. They realize that research is a must, and they call Dr. D to help them get started. Dr. D provides an explanation of the layers of the Earth and how fossils helped scientists discover the movement of the Earth's crust. He also tells them that the answer to a problem is not always obvious. The detectives begin to think of possibilities other than earthquakes that could have caused the ground to shake.

To further investigate the movement of the Earth's crust, Jacob visits Dinosaur National Monument in Utah and decides that his visit will be a great opportunity to learn more about the crust's movement. There he meets Mr. David Whitman, who tells Jacob about the Continental Drift Theory and how fossils and rocks are clues that help unlock the mystery of our Earth's past. The tree house detectives also contact the United States Geological Survey (USGS) office for information on faults and boundaries.

The tree house detectives continue their investigation at Tidewater Community College in Virginia Beach, Virginia, where Mr. Michael Lyle shows them how earthquakes are recorded, and Dr. D explains how they can make their own seismometer. They carry on with their quest at the NASA Jet Propulsion Laboratory (JPL), where Andrea Donnellan demonstrates how NASA monitors crustal movement from space.

The tree house detectives think they are getting close to solving the mystery, and R.J. and Jacob agree to meet Dr. D at the California Academy of Sciences in San Francisco, California to learn more about earthquake waves and how they travel. Dr. Carol Tang joins them and explains how earthquakes are measured and how they destroy buildings. Dr. D, Dr. Tang, R.J., and Jacob all hang on for a wild ride as they "experience" an earthquake in the earthquake room at the Academy.

Back in the tree house, the detectives dial up a NASA SCI Files™ Kids Club in Norfolk, Virginia to learn how the epicenter of an earthquake is located. Finally, the detectives head back to JPL to speak with Ron Baalke to learn about something totally unexpected and discover the answer to why they are "all shook up!"



National Science Standards (Grades K - 4)

Standard	Segment			
	1	2	3	4
Unifying Concepts and Processes				
Systems, orders, and organization	X	X	X	X
Evidence, models, and explanations	X	X	X	X
Change, constancy, and measurement	X	X	X	X
Form and Function	X	X	X	X
Science and Inquiry (Content Standard A)				
Abilities necessary to do scientific inquiry	X	X	X	X
Understanding about scientific inquiry	X	X	X	X
Physical Science (Content Standard B)				
Properties of objects and materials	X	X	X	X
Position and motion of objects	X	X	X	X
Life Science (Content Standard C)				
Organisms and their environments	X	X	X	X
Earth and Space Science (Content Standard D)				
Properties of Earth Materials	X	X	X	X
Changes in Earth and Sky	X	X	X	X
Science and Technology (Content Standard E)				
Abilities of technological design	X	X	X	X
Understanding about science and technology	X	X	X	X
Ability to distinguish between natural objects and objects made by humans	X	X	X	X
Science in Personal and Social Perspective (Content Standard F)				
Personal health			X	X
Changes in environment			X	X
Science and technology in local challenges	X	X	X	X
History and Nature of Science (Content Standard G)				
Science as a human endeavor	X	X	X	X



National Science Standards (Grades 5 - 8)

Standard	Segment			
	1	2	3	4
Unifying Concepts and Processes				
Systems, order, and organization	X	X	X	X
Evidence, models, and explanations	X	X	X	X
Change, constancy, and measurement	X	X	X	X
Form and Function	X	X	X	X
Science as Inquiry (Content Standard A)				
Abilities necessary to do scientific inquiry	X	X	X	X
Understanding about scientific inquiry	X	X	X	X
Physical Science (Content Standard B)				
Properties and changes of properties in matter	X			
Motion and forces	X	X	X	X
Transfer of energy			X	X
Earth and Space Science				
Structure of the Earth system	X	X	X	X
Earth's history	X	X	X	X
Science and Technology (Content Standard E)				
Abilities of technological design	X	X	X	X
Understanding about science and technology	X	X	X	X
Science in Personal and Social Perspectives (Content Standard F)				
Personal health			X	X
Risks and benefits			X	X
Science and technology in society	X	X	X	X
History and Nature of Science (Content Standard G)				
Science as a human endeavor	X	X	X	X
Nature of science	X	X	X	X
History of Science	X			

National Mathematics Standards (Grades 3 – 5)

Standard	Segment			
	1	2	3	4
Number and Operations				
Understand numbers, ways of representing numbers, relationships among numbers, and number systems.	X		X	
Understand meanings of operations and how they relate to one another.	X			
Compute fluently and make reasonable estimates.	X			
Algebra				
Understand patterns, relations, and functions.			X	X
Represent and analyze mathematical situations and structures using algebraic symbols.				X
Use mathematical models to represent and understand quantitative relationships.				X
Analyze change in various contexts.				X
Geometry				
Analyze characteristics and properties of two- and three-dimensional geometric shapes and develop mathematical arguments about geometric relationships.	X			
Measurement				
Understand measurable attributes of objects and the units, systems, and processes of measurement.	X		X	X
Apply appropriate techniques, tools, and formulas to determine measurements.				X
Data Analysis and Probability				
Formulate questions that can be addressed with data and collect, organize, and display relevant data to answer them.	X	X	X	X
Develop and evaluate inferences and predictions that are based on data.			X	X
Understand and apply basic concepts of probability.	X	X	X	X
Problem Solving				
Solve problems that arise in mathematics and in other contexts.	X	X	X	X
Apply and adapt a variety of appropriate strategies to solve problems.	X	X	X	X
Communication				
Analyze and evaluate the mathematical thinking and strategies of others.			X	X
Use the language of mathematics to express mathematical ideas precisely.			X	X

National Mathematics Standards (Grades 3 - 5) Continued

Standard	Segment			
	1	2	3	4
Connections				
Recognize and use connections among mathematical ideas.				X
Recognize and apply mathematics in contexts outside of mathematics.	X		X	X
Representation				
Select, apply, and translate among mathematical representations to solve problems.	X	X	X	X
Use representations to model and interpret physical, social, and mathematical phenomena.			X	X



National Technology Standards (ITEA Standards for Technology Literacy, Grades 3 – 5)

Standard	Segment			
	1	2	3	4
Nature of Technology				
Standard 1: Students will develop an understanding of the characteristics and scope of technology.	X	X	X	X
Standard 2: Students will develop an understanding of the core concepts of technology.	X	X	X	X
Standard 3: Students will develop an understanding of the relationships among technologies and the connections between technology and other fields of study.	X	X	X	X
Technology and Society				
Standard 6: Students will develop an understanding of the role of society in the development and use of technology.	X	X	X	X
Standard 7: Students will develop an understanding of the influence of technology on history.	X			
Abilities for a Technological World				
Standard 12: Students will develop abilities to use and maintain technological products and systems.	X	X	X	X
Standard 13: Students will develop abilities to assess the impact of products and systems.	X	X	X	X
The Designed World				
Standard 17: Students will develop an understanding of and be able to select and use information and communication technologies.	X	X	X	X

National Technology Standards (ISTE National Educational Technology Standards, Grades 3 – 5)

Standard	Segment			
	1	2	3	4
Basic Operations and Concepts				
Use Keyboards and other common input and output devices efficiently and effectively.	X	X	X	X
Discuss common uses of technology in daily life and the advantages and disadvantages those uses provide.	X	X	X	X
Social, Ethical, and Human Issues				
Discuss common uses of technology in daily life and the advantages and disadvantages those uses provide.	X	X	X	X
Technology Productivity Tools				
Use general purpose productivity tools and peripherals to support personal productivity, remediate skill deficits, and facilitate learning throughout the curriculum.	X	X	X	X
Use technology tools for individual and collaborative writing, communication, and publishing activities to create knowledge products for audiences inside and outside the classroom.	X	X	X	X
Technology Communication Tools				
Use technology tools for individual and collaborative writing, communication, and publishing activities to create knowledge products for audiences inside and outside the classroom.	X	X	X	X
Use telecommunication efficiently and effectively to access remote information, communicate with others in support of direct and independent learning, and pursue personal interests.	X	X	X	X
Use telecommunication and online resources to participate in collaborative problem-solving activities for the purpose of developing solutions or products for audiences inside and outside the classroom.	X	X	X	X
Technology Research Tools				
Use telecommunication and online resources to participate in collaborative problem-solving activities for the purpose of developing solutions or products for audiences inside and outside the classroom.	X	X	X	X
Use technology resources for problem solving, self-directed learning, and extended learning activities.	X	X	X	X
Determine when technology is useful and select the appropriate tools and technology resources to address a variety of tasks and problems.	X	X	X	X
Technology Problem-Solving and Decision-Making Tools				
Use technology resources for problem solving, self-directed learning, and extended learning activities.	X	X	X	X



The National Geography Standards, Grades 3 – 5)

Standard	Segment			
	1	2	3	4
The World in Spatial Terms				
How to use maps and other graphic representations, tools, and technologies to acquire process and report information from a spatial perspective.	X	X	X	X
Places and Regions				
The physical and human characteristics of places.	X	X	X	X
That people create regions to interpret Earth's complexity.	X	X	X	X
Physical Systems				
The physical process that shape the patterns of Earth's surface.	X	X	X	X
Environment and Society				
How physical systems affect human systems.	X	X	X	X
The Uses of Geography				
How to apply geography to interpret the past.	X	X	X	X
How to apply geography to interpret the present and plan for the future.	X	X	X	X



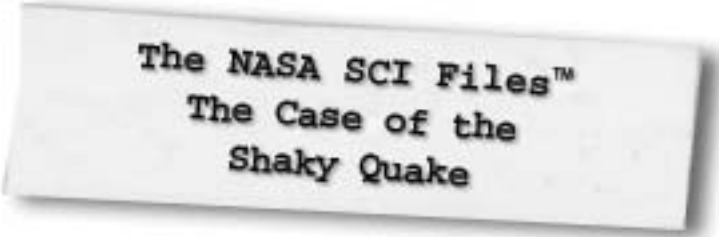

The NASA SCI Files™
The Case of the
Shaky Quake

Segment 1

The tree house detectives are concerned about a tremor that they felt while working in the tree house. Unsure if they had just experienced an earthquake, they decide to call a seismologist to find the answer. They soon realize that it isn't that simple. As the detectives begin their research, they stop by to see Dr. D, who provides them with information on the various layers of the Earth and how fossils help scientists discover the Earth's movement. Dr. D also tells them to think "outside of the box" because the answer is not always obvious. Jacob is on vacation in Utah and visits David Whitman at Dinosaur National Monument to gather some important clues and to learn about the Continental Drift Theory and plate tectonics.

Objectives

The students will

- learn that the interior of the Earth is divided into layers.
- understand continental drift.
- learn that fossils provide evidence about the nature of the environment in which they lived.
- learn that the surface of the Earth slowly changes through time.
- learn the theory of plate tectonics.

Vocabulary

continental drift—a hypothesis that continents have moved around the globe thousands of kilometers over millions of years to reach their current location

crust—the outermost layer of the Earth

density—how tightly packed a substance's molecules are

earthquake—the movement of the ground caused by waves from energy released as rocks move along faults

fossils—the remains or traces of a once-living organism; usually preserved in rock

inner core—the solid center of the Earth

mantel—the thickest layer inside the Earth; it lies between the outer core and the crust

outer core—a liquid layer of Earth's core that surrounds the solid inner core

Pangaea—the name Alfred Wegener gave to the landmass that he believed existed before it split apart to form the present continents

plate tectonics—the theory that Earth's crust and upper mantle exist in sections called plates and that these plates slowly move around on the mantle

seismogram—the record of an earth tremor as made by a seismograph

seismograph—an instrument that records earthquake waves

seismologist—a scientist who studies earthquakes and waves

vibration—a trembling motion



Video Component

Implementation Strategy

The NASA SCI Files™ is designed to enhance and enrich the existing curriculum. Two to three days of class time are suggested for each segment to fully use video, resources, activities, and web site.

Before Viewing

1. Prior to viewing Segment 1 of *The Case of the Shaky Quake*, read the program overview (p.5) to the students. List and discuss questions and preconceptions that students may have about earthquakes, the layers of the Earth, and fossils.

2. Record a list of issues and questions that the students want answered in the program. Determine why it is important to define the problem before beginning. From this list, guide students to create a class or team list of three issues and four questions that will help them to better understand the problem. The following tools are available in the educator area under

Careers

seismologist
park ranger
geologist
oceanographer
paleontologist

the resources section of the web site to assist in the process.

Problem Board -

Printable form to create student or class K-W-L chart

Problem Based Learning (PBL)

Questions - Questions

for students to use while conducting research

Problem Log - Printable log for students with the stages of the problem-solving process

The Scientific Method - Chart that describes the scientific method process

3. Focus Questions - Questions at the beginning of each segment that help students focus on a reason for viewing and can be printed ahead of time from the educator's area of the web site so students can copy them into their science journals. Encourage students to take notes during the program to answer the questions. An icon will appear when the answer is near.
4. What's Up? Questions - Questions at the end of the segment help students predict what actions the tree house detectives should take next in the investigation process and how the information

learned will affect the case. These questions can be printed from the web site ahead of time for students to copy into their science journals.

View Segment 1 of the Video

For optimal educational benefit, view *The Case of the Shaky Quake* in 15-minute segments and not in its entirety. If you are viewing a taped copy of the program, you may want to stop the video when the Focus Question icon appears to allow students time to answer the question.

After Viewing

1. Have students reflect on the "What's Up?" questions asked at the end of the segment.
2. Discuss the Focus Questions.
3. Students should work in groups or as a class to discuss and list what they know about earthquakes, the layers of the Earth, fossils, and plate movement. Have the students brainstorm ideas on what could have caused the tremor that the tree house detectives felt. As a class, reach a consensus on what additional information is needed. Have the students conduct independent research or provide students with the information needed.
4. Have the students complete Action Plans, which can be printed from the web site, and then conduct independent or group research by using books and internet sites noted in the Research Rack section of the NASA SCI Files™ web site. Educators can also search for resources by topic, episode, and media type under the Educator's main menu option *Resources*.
5. Choose activities from the educator guide and web site to reinforce concepts discussed in the segment. The variety of activities is designed to enrich and enhance your curriculum. Activities may also be used to help students "solve" the problem along with the tree house detectives.
6. Have the students work individually, in pairs or in small groups, on the Problem-Based Learning (PBL) activity on the NASA SCI Files™ web site.
 - To begin the PBL activity, read the scenario to the students.



- Read and discuss the various roles involved in the investigation.
- Print the criteria for the investigation and distribute.
- Have students use the Research Rack located on the web site and the online tools that are available.

7. Having students reflect in their journals what they have learned from this segment and from their own experimentation and research is one way to assess the students. In the beginning, students may have difficulty reflecting. To help students, give them specific questions to reflect upon that are related to the concepts.

8. Have students complete a Reflection Journal, which can found in the Problem-Solving Tool section of the online PBL investigation or in the Instructional Tools section of the Educator's area.

9. The NASA SCI Files™ web site provides educators with general and specific evaluation tools for cooperative learning, scientific investigation, and the problem-solving process.

Resources (additional resources located on web site)

Books

Cottonwood, Joe: *Quake!* Scholastic, 1995, ISBN 0590222333.

Gallant, Roy A: *Dance of the Continents*. Benchmark Books, 2000, ISBN 0761409629.

Silverstein, Alvin: *Plate Tectonics*. Twenty-First Century Books, 1998, ISBN 076133225.

Simon, Seymour: *Earthquakes*. Morrow Junior Books, 1991, ISBN 0688096336.

Web Sites

Exploratorium—Life Along the Fault Line

This site contains real video clips of experts in the field of geology, along with activities, links, and a place to share your story.

<http://www.exploratorium.edu/faultline/index.html>

Pangaea To the Present: A History of the Earth's Plates

This web site guides the user through the theory of the formation and breakup of Pangaea. The site includes various maps depicting the transformation of Pangaea through time and a model of the Earth's crust.

<http://volcano.und.nodak.edu/vwdocs/vwlessons/lessons/Pangaea/Pangaea1.html>

PBS Online—Earth Science Links: Earthquakes, Volcanoes, & Plate Tectonics

The in-depth activities on this site range from virtual games, to interactive maps of earthquakes and volcanoes, and to quizzes you can take on the information presented.

<http://sciencespot.net/Pages/kdzethsci2.html>

BBC Online—Walking with Dinosaurs

A fantastic web site that includes games, quizzes, fact files, and much more. When it comes to dinosaurs, this web site is one of the best and most complete sites.

available.<http://www.bbc.co.uk/dinosaurs/>

USGS—The Dynamic Earth: The Story of Plate Tectonics

A very in-depth discussion of the theory of plate tectonics. Includes information from the historical perspective up to the effect on people.

<http://pubs.usgs.gov/publications/text/dynamic.html>

The Earth's Layers

This site contains a general overview of the layers of the Earth. It continues to go "deeper" for more specific information about each layer.

http://volcano.und.nodak.edu/vwdocs/vwlessons/lessons/Earths_layers/Earths_layers1.html



Activities and Worksheets

In the Guide

Layering of the Earth
Make flash cards to learn the layers of the Earth.18

Density Determines the Layers
Learn how different densities create layers in the Earth..20

Did You Catch my Drift?
Create a map of Pangaea and learn about the Continental Drift Theory.21

Inventasaurus
Learn the etymology of words and invent a new word of your own as you design a dinosaur.23

Plates On the Move
Create a model of seafloor spreading and learn the theory of plate tectonics. 24

Answer Key
.....26

On the Web

You've Got the Whole World In Your Hands
Create your own model of the Earth's layers with a foam ball.

Dino Connections
Become a paleontologist and learn the difficulty of assembling fossils.

Just How DO These Plates Move?
Discover convection currents and how they explain the movement of Earth's plates.



Layering of the Earth

Purpose

To identify the layers of the Earth

Procedure

1. On the Earth diagram card sheet, cut along the solid lines, creating four separate cards.
2. Use a metric ruler and measure 1.5 cm from the bottom of each card and mark.
3. Draw a line horizontally across the bottom of the card at the mark.
4. At the bottom of one of the cards, write the word "crust."
5. On the same card, use a red marker to outline the crust of the Earth.
6. Repeat with each of the other cards, using "inner core," "outer core," and "mantle," coloring in the appropriate layer of the Earth to match.
7. Using markers, make different colored dots for each card in the top left and bottom right corners.
8. Use the scissors to cut the card along the line that was drawn at the bottom of each card to create a label card.
9. Practice matching each picture to the correct label card. To check to see if you matched them correctly, turn the cards over and check to see if the dots match.
10. Practice with a partner until you are able to identify the layers of the Earth without the labels.

Materials

Earth diagram cards (p. 19)
scissors
metric ruler
markers

Conclusion:

1. Which layer of the Earth do we live on?
2. What is the inner most layer of the Earth?

Extension:

1. Research the layers of the Earth and write a brief description of each layer. Be sure to include what it is made of, how thick it is, whether it is solid or liquid, and so on. Present your findings in a report to the class.
2. Use a hard-boiled egg or a Ding-Dong® cupcake cut in half (with a small piece of candy for the middle) to discuss the layers of the Earth.



Earth Diagram Cards

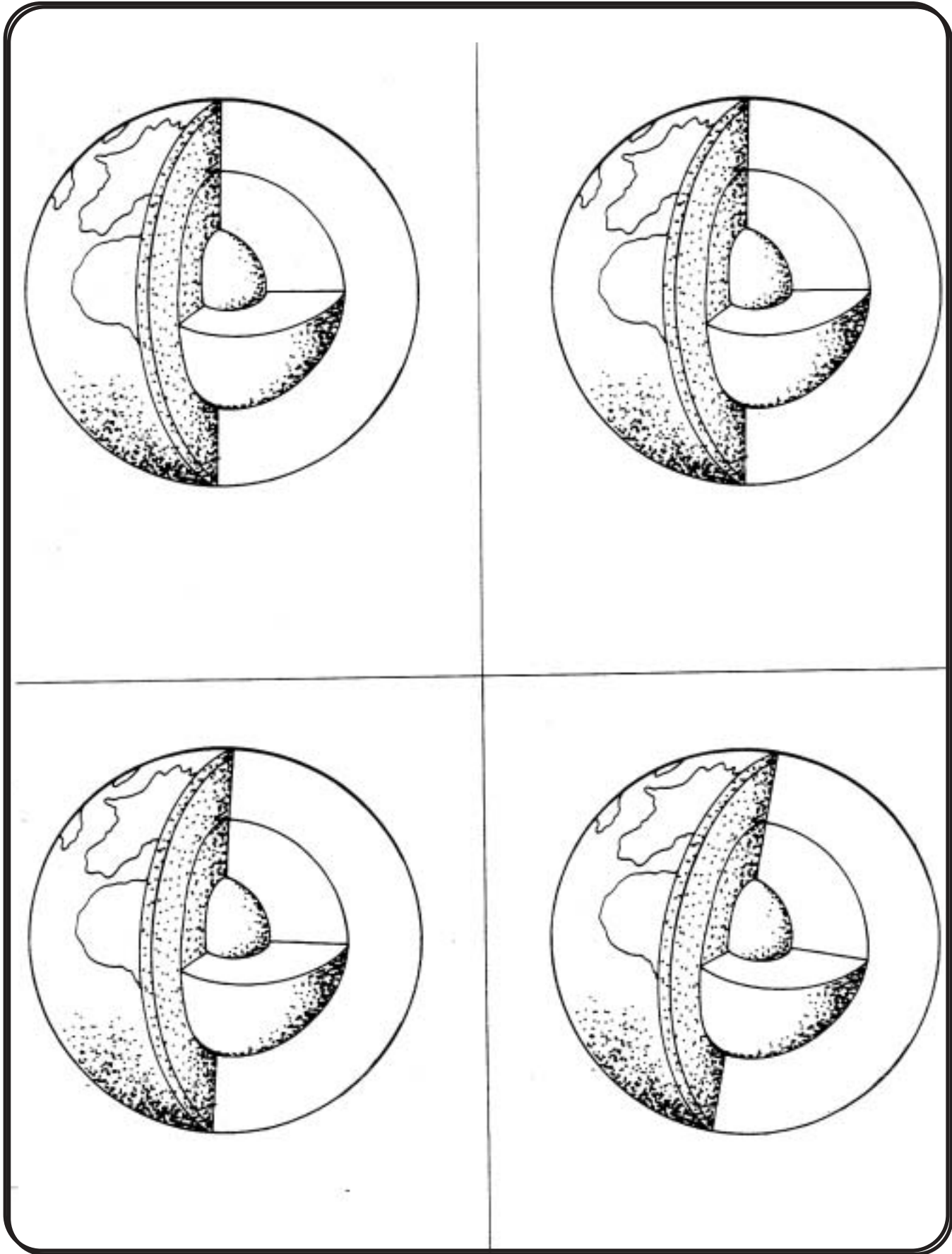

Density Determines the Layers

Purpose

To determine how the density of a substance can create layers

Procedure

1. Pour small, equal amounts of water, corn syrup, and cooking oil into the three cups.
2. Using a different color, add one drop of food coloring to each of the three cups and mix.
3. In your science journal, record what color was used for each substance.
4. One at a time, slowly pour the contents of each cup into the transparent cup.
5. Observe and record what happens to the three different liquids when they are poured into the same cup together.

Materials

3 small cups (of any kind)
1 large transparent cup
food coloring
water
corn syrup
cooking oil

Conclusion

1. Which substance was on the bottom? In the middle? On the top?
2. Why did the layering of the substance occur?
3. Using what you have learned about density, explain how the Earth's layers were formed.

Extension

Carefully pour the following ingredients into a tall glass so that each substance is poured down the inside of the glass: honey, syrup, dish detergent, colored water, cooking oil, and rubbing alcohol. Explain what happened and why some of the substances mixed together. What would happen if you put the substances in the glass in a different order? In your science journal, draw what you observed.

Did You Catch My Drift?

Purpose

To learn about the Continental Drift Theory and to create a map of Pangaea

Procedure

1. Color the legend using a different color for each fossil and rock clue.
2. Using the legend you created, color the fossil and rock clues on the continent pieces to match.
3. Lightly color each continent, being careful to not color over the clues.
4. Cut out the continent pieces.
5. Use the fossil and rock clues to arrange the continents into one large landmass.
6. Once you have determined the best fit, glue the pieces onto a piece of construction paper.
7. Cut out the legend and glue in the lower left corner.
8. Title your map "Pangaea."

Materials

continent pieces (p. 22)
 construction paper
 scissors
 glue
 colored pencils

Conclusion

1. Which two continents have the best fit?
2. Why isn't the fit "perfect" if the continents were once part of Pangaea?

Extension

1. Suppose someone asked if the continents were really together at one time. What kind of information and evidence would you need to support the theory? Write a report explaining how the evidence supports the Continental Drift Theory.
2. After gluing the continents together, draw arrows indicating the direction that the continents have moved over time. Explain what might happen if the continents continue to drift in these directions.

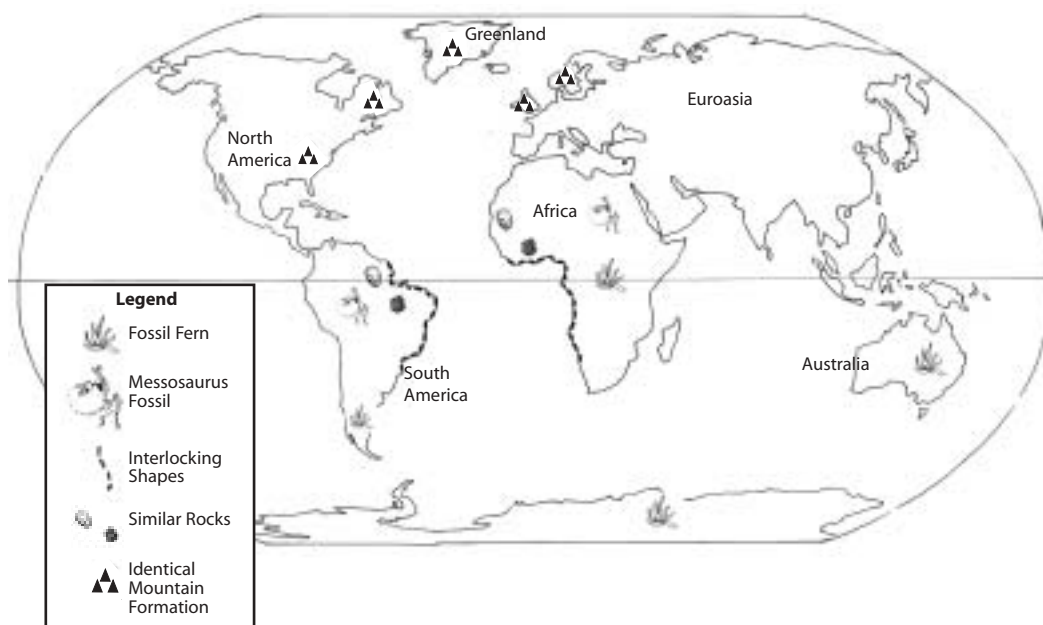

Continent Pieces

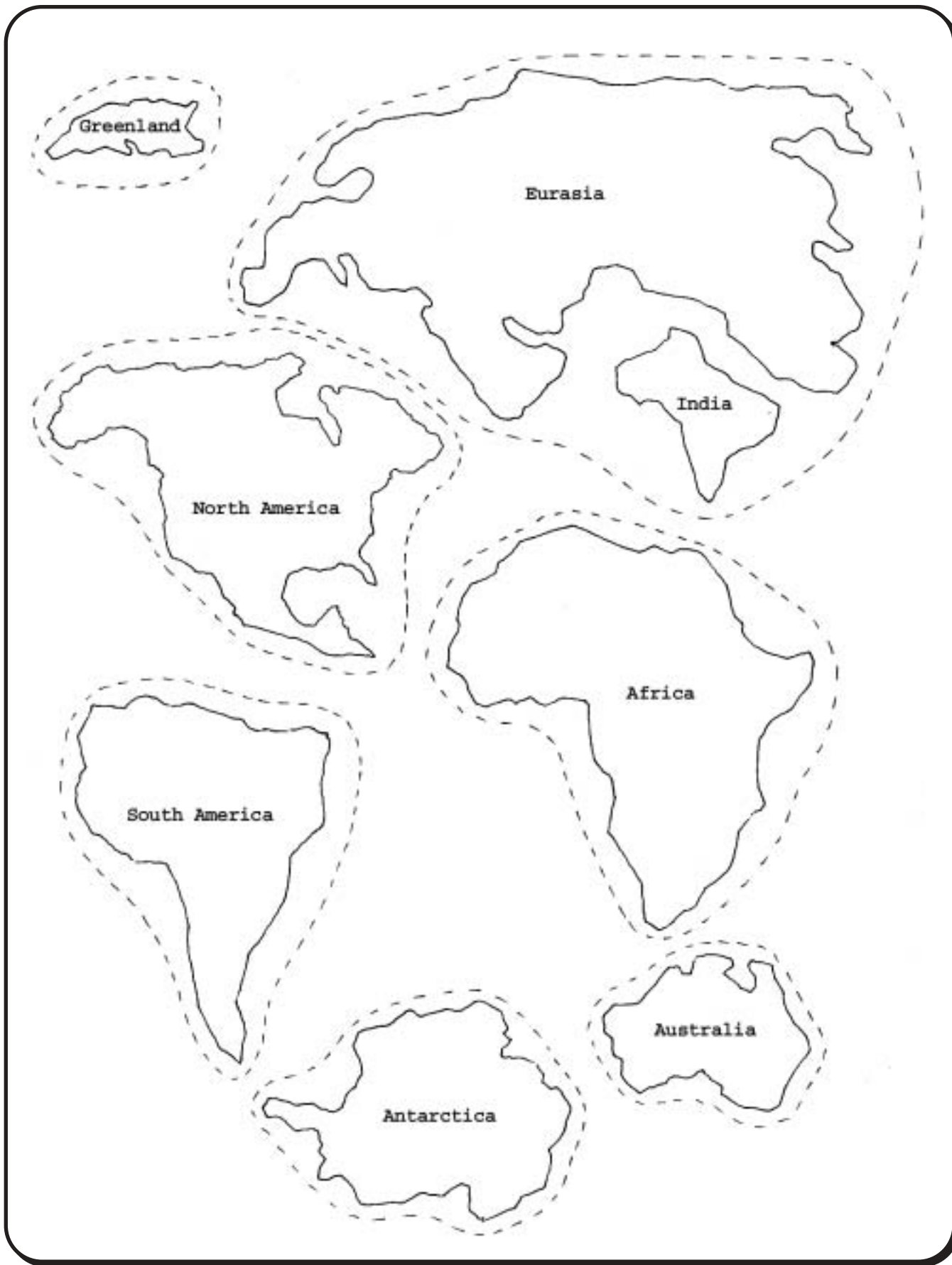

Inventasaurus

Purpose: To learn the etymology of words

Background Etymology is the study of the origin and historical development of a word or parts of words by determining its basic elements, discovering its earliest known use, recoding its changes in form and meaning, tracing its transmission from one language to another, and identifying its roots or origins in other languages. For example, dinosaur: dino means terrible and saur means lizard. A dinosaur is a terrible lizard.

Materials

list of prefixes and suffixes
paper
pencil
colored pencils
construction paper

Procedure

1. Look over the prefixes and suffixes and choose one or one of each to create a new name for a dinosaur. Be creative, think of your favorite movie star or singer and immortalize him or her as a new dinosaur. For example, Jacksonasaur.
2. Write a story about your new dinosaur, being sure to include when it lived, its size, what it ate, how it became extinct, who its natural enemies were, and any other important information.
3. Draw a picture of your dinosaur on the construction paper and present your newly discovered dino to the class.

Prefixes

archaeo, ancient
allo, other
bi, two
coele, hollow
composo, elegant
cory, helmet
crypto, hidden
dino, terrible
diplo, double
glyco, sweet

gorgo, terrible
herb, plant
hetero, different
hexa, six
megalo, great
mono, single
novo, new
osteo, bony
phyto, plant
proto, first

pseudo, fake
quadro, four
salto, leaping
stego, plated
tri, three
trach, duck
tyrannos, terrible

Suffixes

bracchis, arms
canis, dog
captor, hunter
cera, horned
docus, beam
dont, toothed
gnathus, jaw
ichthy, fish
nychus, claw
oculis, eye

ornis, bird
ossa, bones
ped, foot
pteryx, wing
raptor, stealer
rhynchus, nose
saur, lizard
suchus, crocodile
thorium, beast

Plates On the Move

Problem

To understand sea-floor spreading and the theory of plate tectonics

Background

Until the early 1950s, little was known about the ocean floor. The technology needed to explore the deep oceans had not yet been invented. Scientists began using echo-sounding devices to map the ocean floor, and they discovered a complex system of mountains and valleys, just like the continents above the water. They also found a system of ridges and valleys extending through the center of the Atlantic and other oceans around the world. These mid-ocean ridges form an underwater mountain range that extends through the center of much of the Earth's oceans. In the early 1960s, a scientist named Harry Hess suggested an explanation for these mid-ocean ridges. His now accepted theory is known as seafloor spreading. Hess suggested that molten material in the mantle rises to the surface at a mid-ocean ridge, and it then turns and flows sideways, carrying the seafloor away from the ridge in both directions. With the discovery of seafloor spreading, scientists began to understand what was happening to Earth's crust and upper mantle. The idea of sea-floor spreading showed that the continents were not just moving as Wegener suggested, but that there are sections of the seafloor and continents that move around in relation to one another. In 1968 scientists had developed a new theory that combined the main ideas of continental drift and seafloor spreading. The theory became known as the theory of plate tectonics, and it stated that the Earth's crust and upper mantle are broken into sections called plates. These plates move around on the mantle, and the continents can be thought of as "rafts" that float on the mantle.

Materials

2 sheets of white paper
scissors
colored pencils
metric ruler

Procedure

1. Use the ruler to measure and draw three 10-cm lines on one of the sheets of paper. See diagram 1.
2. Draw mountain peaks between the edges of the paper and the outer lines.
3. Use scissors to make a slit along each of the lines drawn.
4. On the second sheet of paper, draw lines approximately 1 cm apart across the width of the paper.
5. Fold the paper in half lengthwise. Cut along the fold.

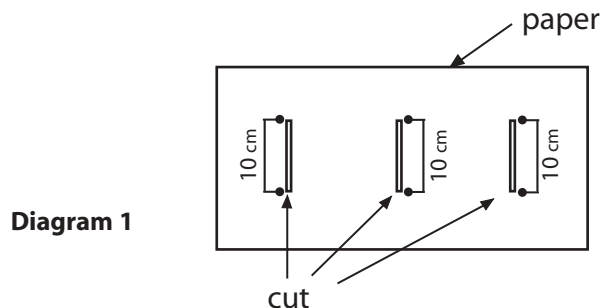

Plates On the Move (continued)

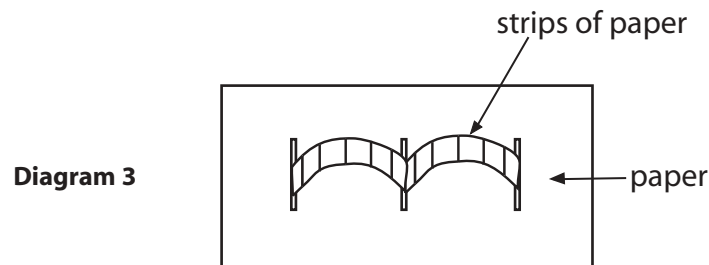
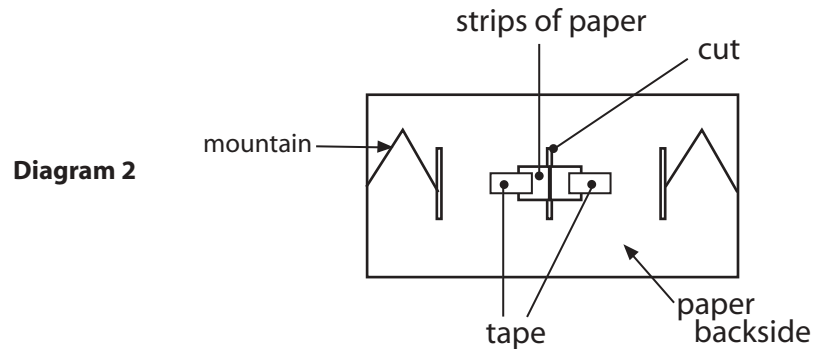

6. Put the two strips face to face, matching the stripes in the middle.
7. Put them through the middle slit from the back to the front.
8. On the back, tape the strips to secure them in place. See diagram 2.
9. Pull both strips about 6 cm out of the center slit and insert each strip into the outer slit closest to it. See diagram 3.
10. Continue to pull the strips through the slit and observe. Record your observations.

Conclusion

1. What does the middle slit or opening of the model represent?
2. How is actual seafloor spreading similar to your model?
3. Where are the youngest rocks found on the ocean floor? The oldest rocks?
4. How does seafloor spreading support the theory of plate tectonics?

Extension

Research and perform experiments on convection to understand the mechanism that drives seafloor spreading. A convection activity can be found on the NASA SCI Files™ web site <<http://scifiles.larc.nasa.gov>> in *The Case of the Phenomenal Weather* guide on page 22.

Answer Key

Layering of the Earth

1. We live on the layer of the Earth called the crust.
2. The inner-most layer of the Earth is the inner core.

Density Determines the Layers

1. The corn syrup was on the bottom, the oil was in the middle, and the water was on the top.
2. The layering occurred because the substances were different densities. The corn syrup was the most dense with water being the least dense. If a substance is denser than something else, the substance will tend to sink to the bottom. This tendency is seen in this experiment. Since the volume of each of the three liquids was equal, and density is equal to the mass divided by the volume, the densest substance is also the heaviest substance. And, of course, heavier objects do sink to the bottom.
3. The layers of the Earth were formed as the denser materials sank to the inner portion of the Earth with the less dense materials, such as our crust, remaining on top.
4. **Extension:** Some of the liquids such as detergent and water, will mix together because the chemicals will dissolve each other. Some of the liquids, such as water and oil, will stay separate because they do not mix.

Did You Catch My Drift?

1. South America and Africa have the best fit.
2. When looking at the continents from a map perspective, much of the continent is not seen. We only map the part of the land that is above the surface of the water. However, much of each continent is below the surface of the water as they extend below sea level as continental shelves. Because of this, the continents do not fit perfectly.

Plates On the Move

1. The middle slit represents a mid-ocean ridge where the molten materials from the mantle rise to the surface of the Earth. This ridge is also known as a divergent plate boundary.
2. The model resembles actual seafloor spreading in that it shows how the molten material rises to the surface and then spreads out in both directions. The striped lines can represent the rocks being formed at the same time on either side of a ridge or they can represent the magnetic field of the crust and how it has reversed over time. Scientists have found that rocks on the ocean floor show many magnetic reversals and that the reversals align on both sides of a ridge.

3. The youngest rocks are located at the mid-ocean ridge, and they become increasingly older the farther they are from the ridge on both sides. Remember pulling the strips out of the slit? The ones that came out first (oldest) are now on the outer edge. Scientists also found that no rocks are older than 200 million years, even though continental rocks are more than three billion years old.
4. By examining the clues of rocks and fossils and proving that the seafloor spreads, scientists were able to support the theory of plate tectonics.

On the Web

You've Got the Whole World in Your Hands

1. The layers of the Earth are the inner core, outer core, mantle, and crust.
2. We live on the Earth's crust.

Dino Connections

1. Answers will vary but might include that it was difficult to put the pieces together because some of the pieces are crushed or that there were three "fossils" mixed together.
2. When paleontologists work in the field to piece together fossilized bones, they are not always sure if all of the bones are present. Some may have been destroyed by other dinosaurs at the time of the animal's death or simply not fossilized. Earth's processes such as floods, earthquakes, and such may have also disturbed the bones.
3. Apatosaurus was named a Brontosaurus until scientists discovered that bones in his head were not correctly put together.

How DO Those Plates Move?

1. The paper circles move around on the surface of the water. As the ice cools the surrounding water, it sinks to the bottom of the dish. As the cooler, denser water sinks, it forces the warmer less dense water to rise and replace the cooler water. As the warmer water moves and cools, it sinks and the cycle is started once again. This motion of sinking and rising causes the paper circles to move.
2. Some of the red food color will rise to the top and float towards the other end of the dish.
3. Some of the blue food color will sink and move along the bottom of the dish towards the other end of the dish.
4. Answers will vary but should include that the mantle material close to the Earth's core is very hot. Mantle material farther from the core is cooler and denser. The cooler material sinks towards the Earth's core and the hot material is pushed up to replace the cooler material. As the cooler material starts to sink near the core, it gets heated and starts to rise once again. Thus, the cycle continues over and over. This circular motion carries the plates along with it, which in turn causes the continents to move.



The NASA SCI Files™
The Case of the
Shaky Quake

Segment 2

After investigating various leads, the tree house detectives think that an explosion caused the tremor felt in the tree house. However, they don't want to jump to conclusions too quickly and feel that more research is needed. After researching plate tectonics, the detectives decide that they need to learn more about faults, and they ask Jacob and R.J. to contact the United States Geological Survey (USGS) office for information on faults and plate boundaries. Meanwhile, back at home, the rest of the detectives set off for Tidewater Community College in Virginia Beach, Virginia, where Mr. Michael Lyle shows them how earthquakes are recorded. They also meet Dr. D who demonstrates how to make their very own seismometer.

Objectives

The students will

- explain how earthquakes occur.
- identify three types of faults.
- identify three types of plate boundaries.
- understand folklore and legends of earthquakes.

Vocabulary

convergent boundary—in plate tectonics, the boundary between two plates that are converging or moving toward each other

divergent boundary—in plate tectonics, the boundary between two plates that are diverging or spreading apart

fault—a large break in rocks, from several meters to many kilometers long, where rocks not only crack but also move along either side of the break

inertia-- tendency of objects to remain in motion or stay at rest unless acted upon by an unbalanced force

intraplate earthquake—earthquake located in the interior of a plate

- build a model of a seismometer.

normal fault—a pull-apart (tension) fracture in rocks, where rocks that are above the fault surface drop downward in relation to rocks that are below the fault surface

reverse fault—a compression fracture in rocks, where rocks that are above the fault surface are forced up over rocks that are below the fault surface

strike-slip fault—a break in rocks where rocks on either side of the fault move past each other (instead of above or below each other)

transform boundary—in plate tectonics, a boundary between two plates that are sliding past one another

Video Component

Implementation Strategy

The NASA SCI Files™ is designed to enhance and enrich the existing curriculum. Two to three days of class time are suggested for each segment to fully use video, resources, activities, and web site.

Before Viewing

1. Prior to viewing Segment 2 of *The Case of the Shaky Quake*, discuss the previous segment to review the problem and what the tree house detectives have learned thus far. Download a copy of the Problem Board from the NASA SCI Files™ web site and have students use it to sort the information learned so far.
2. Review the list of questions and issues that the students created prior to viewing Segment 1 and determine which, if any, were answered in the video or in the students' own research.
3. Revise and correct any misconceptions that may have been dispelled during Segment 1. Use tools

located on the Web, as was previously mentioned in Segment 1.

4. Focus Questions—Print the questions from the web site ahead of time for students to copy into their science journals. Encourage students to take notes during the program to answer the questions. An icon will appear when the answer is near.
5. What's Up? Questions—Questions at the end of the segment help students predict what actions the tree house detectives should take next in the investigation process and how the information learned will affect the case. These questions can be printed from the web site ahead of time for students to copy into their science journals.

View Segment 2 of the Video

For optimal educational benefit, view *The Case of the Shaky Quake* in 15-minute segments and not in its entirety. If you are viewing a taped copy of the program, you may want to stop the video when the



Focus Question icon appears to allow students time to answer the question.

After Viewing

1. Have students reflect on the "What's Up?" questions asked at the end of the segment.
2. Discuss the Focus Questions.
3. Have students work in small groups or as a class to discuss and list what new information they have learned about the layers of the Earth, fossils, and plate movement. Organize the information and determine if any of the students' questions from Segment 1 were answered.
4. Decide what additional information is needed for the tree house detectives to determine what caused the tremor. Have students conduct independent research or provide students with information as needed. Visit the NASA SCI Files™ web site for an additional list of resources for both students and educators.
5. Choose activities from the educator guide and web site to reinforce concepts discussed in the segment. Pinpoint areas in your curriculum that may need to be reinforced and use activities to aid student understanding in those areas.
6. If time did not permit you to begin the web activity at the conclusion of Segment 1, refer to number 6 under "After Viewing" on page 15 and begin the Problem-Based Learning activity on the NASA SCI Files™ web site. If the web activity was begun, monitor students as they research within their selected roles, review criteria as needed, and encourage the use of the following portions of the online, Problem-Based Learning activity:
 - Research Rack** - books, internet sites, and research tools
 - Problem-Solving Tools** - tools and strategies to help guide the problem-solving process
 - Dr. D's Lab** - interactive activities and simulations
 - Media Zone** - interviews with experts from this segment
 - listing of Ask-An-Expert sites and biographies of experts featured in the broadcast
7. Have students write in their journals what they have learned from this segment and from their own experimentation and research. If needed, give students specific questions to reflect upon as suggested on the PBL Facilitator Prompting Questions instructional tool found in the educator's area of the web site.
8. Continue to assess the students' learning, as appropriate, by using their journal writings, problem logs, scientific investigation logs, and other tools that can be found on the web site. Visit the Research Rack in the tree house, the online PBL investigation main menu section "Problem-Solving Tools," and the "Tools" section of the educator's area for more assessment ideas and tools.

Careers

metallurgical engineer
gemologist
soil engineer

Resources

Books

Kerhet, Peg: *Earthquake Terror*. Sea Star Books, 1998, ISBN 0613068114.

Lassieur, Allison: *Earthquakes*. Capstone Books, 2001, ISBN 0763805869.

Sattler, Helen Rodney: *Our Patchwork Planet*. Lothrop, Lee, and Shepary Books, 1995, ISBN 0688093124.

Video

Earth Revealed. The Annenberg/CPB Collection, 1992, ISBN 155464437.

Web Sites

Earthquakes

This site is packed with information on earthquakes. Learn what to do during a quake, read a map to discover earthquake prone areas, discover ancient legends that were used to explain quakes, and much more. Presented in a kid friendly environment.
<http://www.fema.gov/kids/quake.htm>

Earthquake Legends

This site is full of legends and folklore about how earthquakes are explained by various cultures.
<http://www.fema.gov/kids/eqlegend.htm>

Life Along the Fault Line

This cool site contains real video clips of experts in the field of geology. It contains activities, links, and a place to share your story. It also has past webcasts that can be viewed.

<http://www.exploratorium.edu/faultline/index.html>

Plate Tectonics: The Cause of Earthquakes

A good discussion about how plate tectonics and earthquakes go hand in hand. Information is also available about the three types of plate boundaries.
<http://www.seismo.unr.edu/ftp/pub/louie/class/100/plate-tectonics.html>

How Stuff Works: How Earthquakes Work

Learn more about the dynamics of earthquakes and find many links to other sites.

<http://www.howstuffworks.com/earthquake.html>

USGS: Earthquake Hazards Program

The USGS site has so many resources to use that it would be impossible to list them. You can view current earthquake activity, news, and even request earthquake notification via e-mail.

<http://neic.usgs.gov/>



Activities and Worksheets

In the Guide	Breaking Loose Learn how earthquakes are created along fault lines.	32
	It's Not My Fault! Create cardboard models of three types of faults.	33
	Shaky Quake Cake Make edible models of three types of plate boundaries.	34
	Folklore and Legends Read and research legends and how various cultures explain the trembling Earth.	35
	Got Quakes? Build your own seismometer.	36
	Answer Key	38

On the Web	Plates On a Globe Create a model of the lithospheric plates by using a tennis ball.	
	Modeled to a Fault Create 3-dimensional paper models of three types of faults.	



Breaking Loose

Problem To explain how earthquakes occur

Procedure

1. Securely tape one piece of sandpaper in place on a flat surface.
2. Wrap the other piece of sandpaper around the small block of wood and secure it with tape.
3. On the top of the small block of wood, attach a rubber band with a tack. See Diagram 1.
4. Lay the block of wood, sandpaper side down, on top of the sandpaper attached to the table. See diagram 2.
5. Very slowly begin to pull on the block with the rubber band. Notice that the force of your pulling builds up in the rubber band.
6. Continue to pull until the block moves. Record your observations in your science journal.

Materials

small wooden block
rubber band
2 pieces of sandpaper
tack
science journal

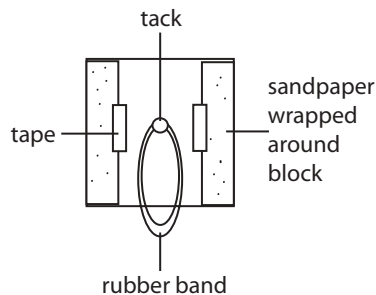

Diagram 1

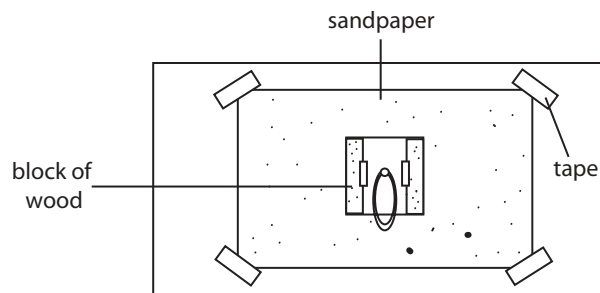

Diagram 2

Conclusion

1. What happened when you continued to pull on the rubber band? Why?
2. Explain how this simulation relates to earthquakes.
3. Use the Internet, books, and other resources to research the elastic rebound theory and create a report for the class.

It's Not My Fault!

Problem To identify three types of faults

Procedure

1. On the cardboard, use a metric ruler to draw two rectangles that each measure 16 cm X 9 cm.
2. Cut out the two rectangles.
3. Use the ruler to divide each rectangle into three equal lengthwise parts. See diagram 1.
4. Label one rectangle, "Rectangle A" and label the parts 1, 2, and 3. Color each part a different color.
5. Repeat with the second rectangle, labeling it "Rectangle B."
6. On Rectangle A, measure 2 cm from the upper left corner and mark.
7. Measure 2 cm from the bottom right corner and mark.
8. Draw a diagonal line between the two marks. See diagram 2.
9. Using scissors, cut along the diagonal line and set aside.
10. On Rectangle B, measure to find the lengthwise middle of the rectangle on the top and bottom.
11. Draw a line between the two marks and cut along the line. See diagram 3.
12. Position Rectangle A in front of you and push against each side so that the right side drops down below the left side to demonstrate a normal fault.
13. Reposition Rectangle A in front of you and push against each side so that the right side pushes above the left side. This demonstrates a reverse fault.
14. Position Rectangle B in front of you and slide the left side past the right side to demonstrate a strike-slip fault.
15. In your science journal, write a description of each fault. In your group or as a class, reach a consensus for a definition of each fault.
16. Research the term "hanging wall" and determine which wall would be the hanging wall in a normal and reverse fault.

Materials

Inclined Plane
 wooden plank or sturdy piece of cardboard
 stack of books
 protractor
 2 paperback books tied together with string
 spring scale

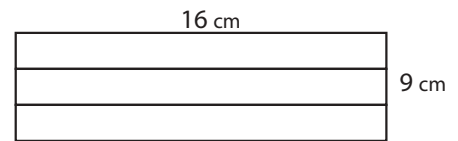

Diagram 1

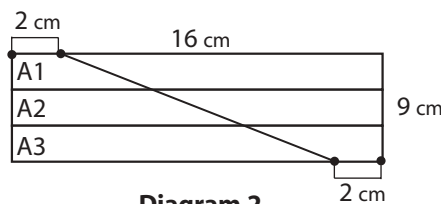

Diagram 2

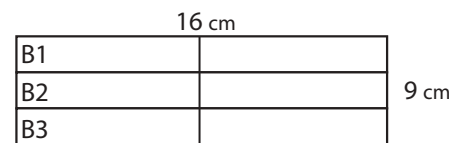

Diagram 3

Conclusions

1. How might each of these faults be created?
2. Are there faults in your local area? How do you know?

Extensions

1. Research what landforms are created by each of these faults.

Shaky Quake Cake

Problem

To identify three types of plate boundaries

Teacher Note:

To demonstrate three types of plate boundaries, you will need three cakes. This activity can be done as a class demonstration, or each group can have a cake to demonstrate one of the plate boundaries.

Procedure

- Starting just underneath the reinforced rim 10 cm from corners, cut one foil pan diagonally from side to side. Leave the rim intact to help hold the pan in position during baking. See diagram 1.
- To reinforce the cut pan, cover the outside with the aluminum foil.
- Place the foil-reinforced pan inside the uncut pan.
- Spray liberally with cooking oil.
- Pour prepared cake batter into the pan. NOTE: To create a layering effect to represent the layering of rocks and soil, use different colored cake batter for each layer. Add nuts, to represent rocks in the soil, coconut to represent plant roots, and so on.
- To make the second cake, repeat steps 1-5 but cut the pan across the center of the pan. See diagram 2.
- To make the third cake, repeat step 6. Once you have cut the pan across the center, slightly overlap the edges in the middle so that they will slide together.
- Bake according to the package or recipe directions.
- Allow the cakes to completely cool.
- If desired, after the cakes have cooled, use different colors of a stiff icing to add roads, streams, hills, and other details to the landscapes of the cakes. The cakes can also be topped with models of animals, cars, trees, trucks, buildings, and so on.
- Carefully remove the cakes from the outer uncut pans. Loosen the aluminum foil from the edges but do not remove from the bottom of the pan.
- Finish cutting the rims so that the pans are no longer connected. Be careful not to fracture the cakes in the process.
- Use the cake that has the pan cut diagonally to demonstrate a transform boundary. You and a partner should firmly grasp the pan at each end. One will slowly move half the pan to the left while the other moves the other side of the pan slowly to the right. Make sure you keep the cake and pan as level as possible.
- Discuss what happened to the "Earth" as you applied pressure to each side.
- To demonstrate a divergent plate boundary, use one of the other cakes and firmly grasp each end. Gently and slowly pull outward on the pan and cake without twisting until the cake begins to fracture.
- Discuss what happened to the "Earth" as it was pulled apart.
- To demonstrate a convergent plate boundary, firmly grasp one end of the pan and have your partner grasp the other end. Gently and slowly push toward each other with steady pressure. The cake should buckle in the middle.
- Discuss what happened to the "Earth" as it was pushed together.
- Answer the conclusion questions and then enjoy the shaky quake cake.

Materials

6 foil pans (30 cm X 40 cm)
cake batter for 3 cakes (prepared)
scissors
3 pieces of aluminum foil
10 cm X 40 cm
cooking oil spray
paper plates
forks
napkins

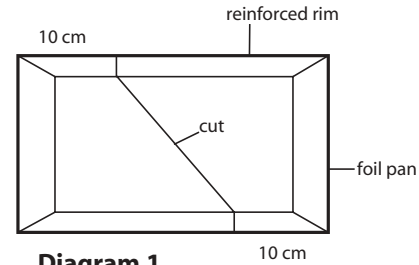

Diagram 1

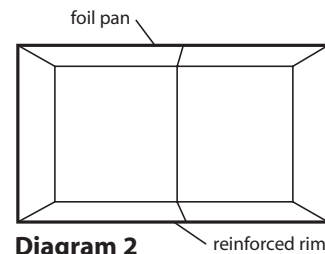

Diagram 2

Conclusion

- Define the three types of plate boundaries and describe how each is created.
- How were the three types of boundaries similar?
- What happened to the cake after the pushing or pulling stopped?



Folklore and Legends

Background Different cultures around the world have attempted to explain earthquakes in various ways. Below are a few legends about what makes the ground shake.

India The Earth is held up by four elephants that stand on the back of a turtle. The turtle is balanced on top of a cobra. When any of these animals move, the Earth trembles and shakes.

Mexico El Diablo, the devil, makes giant rips in the Earth from the inside. He and his devilish friends use the cracks when they want to come and stir up trouble on Earth.

Native American Once a Chickasaw chief was in love with a Choctaw princess. He was young and handsome, but he had a twisted foot, so his people called him Reelfoot. When the princess's father refused to give Reelfoot his daughter's hand, the chief and his friends kidnapped her and began to celebrate their marriage. The Great Spirit was angry and stomped his foot. The shock caused the Mississippi River to overflow its banks and drown the entire wedding party. (Reelfoot Lake, on the Tennessee side of the Mississippi River, was formed as a result of the New Madrid earthquake of 1812.)

Procedure After reading the above legends, conduct research using the Internet, books, or other resources to learn about other legends from around the world. Create a skit, poster, written or oral report, or some other way to introduce the legend to the class.

Extension Create a legend of your own, and illustrate it.



El Diablo Shaking the Earth

Got Quakes?

Problem

To build a model of a seismometer to record the movements in the Earth

Procedure

- Using scissors cut out the two largest faces of the cereal box, leaving a 3-cm border on the top and the two sides. Along the bottom, cut all the way to the edge. See diagram 1.
- Cut a small hole in the top face.
- Use a hole-punch to make two holes on opposite sides of the cup.
- Thread a 10-cm piece of string through each hole and secure each string to the cup by tying a knot in the string.
- Bring the two strings together and tie them in a knot. See diagram 2.
- Tie the 30-cm string to where the 10-cm strings are joined together.
- Make a small hole in the center bottom of the cup and insert a pencil so that it protrudes approximately 1 to 2 cm.
- Place some weights in the bottom of the cup (3-5 marbles or washers).
- Place the lid on the cup so that the eraser end of the pencil is sticking out of the hole where a straw would normally be placed. See diagram 3.
- Thread the 30-cm string through the hole in the top of the cereal box.
- Tie the string around a pencil and lay the pencil flat against the top of the box. The cup should now be suspended from the cereal box. Adjust the string by wrapping it around the pencil until the pencil lead is barely touching the bottom of the box.
- Glue the 3 strips of paper together end to end.
- Place one end of the paper directly under the point of the pencil. The rest of the strip should be flat on the surface on the other side of the box. See diagram 4.
- Assign each member of your group a job.
 - One student will be in charge of shaking the surface that the box is on.
 - One student will pull the paper through the box.
 - One student will lightly hold the box in place so that it doesn't tip over.
 - One student will record the time with a stopwatch.
- After everyone is in place, begin the earthquake and time it for 10 seconds.
- Look at your seismograph and discuss what you have recorded.

Materials

two strings 10 cm long each
one string 30 cm long
paper cup with plastic lid
weights (marbles or washers)
metric ruler
2 pencils
science journal
stopwatch
3 strips of paper, 10 cm x 28 cm
cereal box
scissors
glue

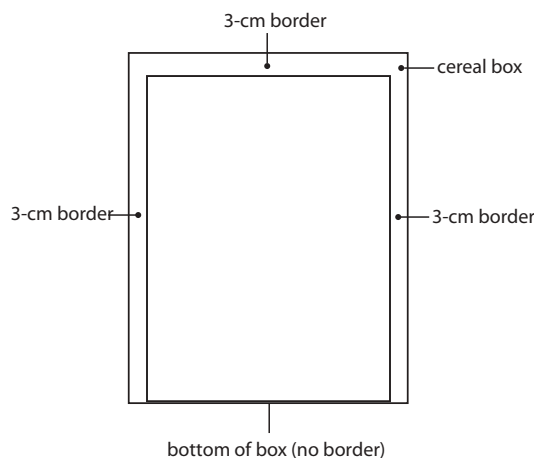

Diagram 1

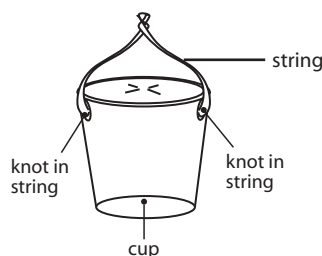

Diagram 2



Got Quakes? (continued)

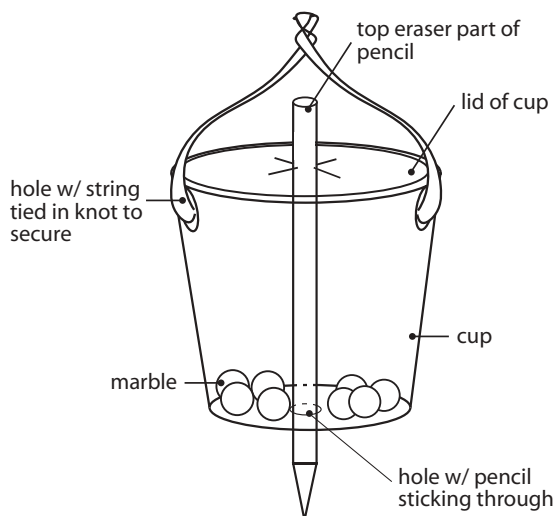

Diagram 3

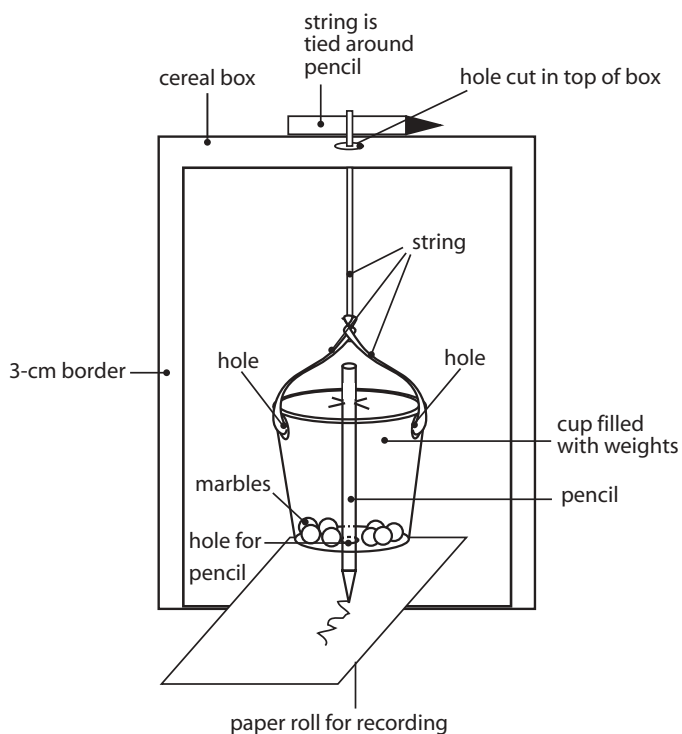

Diagram 4

Conclusion

1. Why do scientists use seismometers?
2. How can they help people that live close to boundaries that move?
3. In what other ways could you use a seismometer?

Answer Key

Breaking Loose

1. As you continued to pull on the rubber band, the force finally overcame friction, and the block leapt forward, skipping over the rough sandpaper surface. The rubber band stored energy until it had enough to overcome the friction of the sandpaper.
2. In most places, plate motion is steady and slow as the plates slide past each other, moving only a few centimeters each year. This kind of motion is referred to as seismic creep. But in some locations where the friction between plates is great, whole sections become stuck against each other. The pressure on the sections increases and eventually this pressure is released. Though rock may seem brittle, it's actually an elastic material, capable of stretching and storing energy like a spring or rubber band and then returning that energy in a sudden rebound. A little bit more plate motion is the final trigger, and the friction between the plates is overcome. A section of the fault suddenly breaks loose, releasing all the stored elastic energy in one sudden jerk.
3. Reports will vary.

It's Not My Fault!

1. Rocks are subjected to tension from the constant movement of the plates. Tension can pull rocks apart to create a normal fault. Think of pulling a piece of clay apart. It takes a lot of effort, but eventually, the clay will snap into pieces. If it were to break into three pieces, the middle piece would fall downward. Compression forces are generated at convergent plate boundaries. Compression pushes on rocks from opposite directions and causes them to bend and fold and sometimes break. At a strike-slip fault, the rocks on either side of the fault surface are moving past each other without much upward or downward motion.
2. Answers will vary. Visit the USGS web site < <http://www.usgs.gov/> > for information on faults in your area.

The Shaky Quake Cake

1. A transform fault (boundary) occurs when two plates slide past each other. Transform faults occur when two plates are moving in opposite directions or in the same direction at different rates. The San Andreas Fault is a transform boundary. A divergent plate boundary is the boundary between two plates that are moving apart from one another. Divergent boundaries can occur when convection currents in the mantle cause two plates to move apart. Seafloor spreading and the Great Rift Valley in eastern Africa are examples of divergent boundaries. Convergent boundaries occur where two plates are colliding. New crust is being added at divergent boundaries, which causes the plates to move away from the fault area. This movement causes the plates to collide in other areas. There are three types of convergent boundaries. One is when the ocean floor plate collides with a less dense continental plate, creating a subduction zone and volcanoes such as those in the Andes Mountains of South America. The second type occurs when two ocean plates collide, forming deep-sea trenches and islands. This type of

collision formed the islands of Japan. The third type occurs when two continental plates collide, crumpling up and forming mountain ranges such as the Himalayan Mountains. There is not a subduction zone because both plates are less dense than the material in the asthenosphere.

2. Answers will vary but should include that the Earth's forces create all three boundaries and that it is the build up of stress and pressure that causes the boundaries to move. The stresses and strains in the Earth's upper layers are induced by many causes: thermal expansion and contraction, gravitational forces, solid-earth tidal forces, specific volume changes because of mineral phase transitions, and so on. Faulting is one of the various manners of mechanical adjustment or release of such stress and strain.
3. When the pushing and pulling stopped, the cake did not snap back to its original form. Fissures, (cracks) in the Earth caused by earthquakes, usually do not close back up but in time they fill in with debris from erosion.

Got Quakes?

1. Seismometers are primarily used to record the movements of the Earth's crust. Scientists use the information obtained by a seismometer to help locate the epicenter (origin) of an earthquake. Scientists can also use the information to help predict future earthquakes and even to map the interior of our Earth. Scientists have begun to estimate the locations and likelihood of future damaging earthquakes. Sites of greatest hazard are being identified, and structures are being designed that will withstand the effects of earthquakes.
2. Seismometers can help people that live close to plate boundaries by helping scientists predict future earthquakes and to warn of earthquakes that have triggered tsunamis.
3. Answers will vary but might include that seismometers can be used to record traffic vibrations, construction blasts, sonic booms, and anything else that would make the ground vibrate.

On the Web

Plates On a Globe

1. There are approximately 10 major plates shown on the globe.
2. The plates are mostly named for the continent on which they are located.
3. Reports will vary.

Modeled to a Fault

1. Answers will vary.
2. Reports will vary.



The NASA SCI Files™
The Case of the
Shaky Quake

Segment 3

As the tree house detectives continue their investigation for the answer to the mysterious tremor, they decide to contact Ms. Andrea Donnellan at NASA's Jet Propulsion Laboratory (JPL) where she explains how the Global Positioning System (GPS) uses satellites to accurately measure any movement in the Earth's crust. Not convinced that it was an earthquake, the detectives brainstorm for other possible solutions but continue their research on earthquakes as Jacob and R.J. meet Dr. D at the California Academy of Sciences in San Francisco, California. There Dr. D explains how earthquakes produce various types of waves and how these waves travel through the Earth's crust. Dr. Carol Tang joins them and explains how earthquakes are measured and how they destroy buildings. Dr. D, Dr. Tang, R.J., and Jacob all hang on for a wild ride as they "experience" an earthquake in the earthquake room at the Academy.

Objectives

The students will

- observe that waves are created when energy is released.
- demonstrate how primary and secondary waves travel.
- understand how soil can liquefy during earthquakes to cause destruction.
- learn the various scales used to measure earthquakes.
- use real time data to locate and analyze earthquakes

Vocabulary

blind fault—a break in the crust that does not break through to the surface

epicenter—the point on Earth's surface directly above an earthquake's focus

focus—in an earthquake, the point in Earth's interior where movement releases energy to cause an earthquake

Global Positioning System (GPS)—satellite navigation system consisting of 24 satellites

moment magnitude scale—a scale used by scientists to measure the energy released by an earthquake

primary (P) waves—waves of energy, released during an earthquake that travel the fastest through

Earth by compressing particles in rocks in the same direction the wave is traveling

Richter scale—describes how much energy is released by an earthquake

secondary (S) waves—waves of energy, released during an earthquake, that travel through the Earth by moving particles in rocks at right angles to the direction the wave is traveling

slip rate—the rate at which two sides of a fault are moving past each other; typically measured in millimeters per year

surface wave—waves of energy, released during an earthquake, that reach Earth's surface and travel outward from the epicenter in all directions

Video Component

Implementation Strategy

The NASA SCI Files™ is designed to enhance and enrich the existing curriculum. Two to three days of class time are suggested for each segment to fully use video, resources, activities, and web site.

Before Viewing

1. Prior to viewing Segment 3 of *The Case of the Shaky Quake*, discuss the previous segment to review the problem and what the tree house detectives have learned thus far. Download a copy of the Problem Board from the NASA SCI Files™ web site and have students use it to sort the information learned so far.
2. Review the list of questions and issues that the students created prior to viewing Segment 2 and determine which, if any, were answered in the video or in the students' own research.
3. Revise and correct any misconceptions that may have been dispelled during Segment 2. Use tools located on the Web, as was previously mentioned in Segment 1.
4. Focus Questions - Print the questions from the web site ahead of time for students to copy into their science journals. Encourage students to take notes during the program to answer the questions. An icon will appear when the answer is near.
5. What's Up? Questions - Questions at the end of the segment help students predict what actions the tree house detectives should take next in the investigation process and how the information learned will affect the case. These questions can be printed from the web site ahead of time for students to copy into their science journals.



View Segment 3 of the Video

For optimal educational benefit, view *The Case of the Shaky Quake* in 15-minute segments and not in its entirety. If you are viewing a taped copy of the program, you may want to stop the video when the Focus Question icon appears to allow students time to answer the question.

After Viewing

1. Have students reflect on the "What's Up?" questions asked at the end of the segment.
2. Discuss the Focus Questions.
3. Have students work in small groups or as a class to discuss and list what new information they have learned about the layers of the Earth, fossils, and plate movement. Organize the information, place it on the Problem Board, and determine if any of the students' questions from Segment 2 were answered.
4. Decide what additional information is needed for the tree house detectives to determine what caused the tremor. Have students conduct independent research

Careers

geophysical technician
museum worker
structural engineer

or provide students with information as needed. Visit the NASA SCI Files™ web site for an additional list of resources for both students and educators.

5. Choose activities from the educator guide and web site to reinforce concepts discussed in the segment. Pinpoint areas in your curriculum that may need to be reinforced and use activities to aid student understanding in those areas.
6. If time did not permit you to begin the web activity at the conclusion of Segments 1 or 2, refer to number 6 under "After Viewing" on page 15 and begin the Problem-Based Learning activity on the NASA SCI Files™ web site. If the web activity was begun, monitor students as they research within their selected roles, review criteria as needed, and encourage the use of the following portions of the online, Problem-Based Learning activity:

Research Rack - books, internet sites, and research tools

Problem-Solving Tools - tools and strategies to help guide the problem-solving process.

Dr. D's Lab - interactive activities and simulations

Media Zone - interviews with experts from this segment

Expert's Corner - listing of Ask-An-Expert sites and biographies of experts featured in the broadcast

7. Have students write in their journals what they have learned from this segment and from their own experimentation and research. If needed, give students specific questions to reflect upon, as suggested on the PBL Facilitator Prompting Questions instructional tool found in the educator's area of the web site.
8. Continue to assess the students' learning, as appropriate, by using their journal writings, problem logs, scientific investigation logs, and other tools that can be found on the web site. Visit the Research Rack in the tree house, the online PBL investigation main menu section "Problem-Solving Tools," and the "Tools" section of the educator's area for more assessment ideas and tools.



Resources

Books

Levy, Matthys and Salvidori, Mario: *Earthquake Games: Earthquakes and Volcanoes Explained By 32 Games and Experiments*. M.K. McElderry Books, 1997, ISBN 0689813678.

Vandeave, Janice Pratt: *Janice VanCleave's Earthquakes: Mind Boggling Experiments You can Turn Into Science Fair Projects*. John Wiley & Sons, Inc., 1993, ISBN 0471571075.

Walker, Bryce S: *Earthquake*. Time-Life Books, 1982, ISBN 0809443007.

Web Sites

Exploratorium: The Great Shake—San Francisco, 1906

Take a virtual walk through the aftermath of the great quake that took place in San Francisco in 1906

while reading descriptive accounts of the day.
<http://www.exploratorium.edu/faultline/1906/index.html>

Kid Zone: A Quiz, Puzzle, and Answers To Your Common Earthquake Questions

Take a quiz, try a crossword puzzle or word search, make your own, or simply find answers to your questions about earthquakes.
<http://www.abag.ca.gov/bayarea/eqmaps/kids.html>

Liquefaction

Learn how soil can act like a liquid. This site features photos and movie clips of liquefaction as it happened.
<http://www.cen.bris.ac.uk/civil/students/eqteach97/geo2.htm>

Activities and Worksheets

In the Guide

Waves in Action

Learn how a release of energy can create waves.43

Have Wave Will Travel

Use a Slinky® to learn the different types of waves.44

Sweet Waves

Prepare your favorite gelatin and learn how waves move.45

The Foolish Man Built His House Upon the Sand

Create an earthquake and learn how sand can liquify and cause major destruction. ...46

California On The Move

Create a flip book to see where California will change 48

Answer Key

..... 50

On the Web

Earthquake, Earthquake, Read All About It!

Learn about the various scales that scientists use to measure earthquakes.

Earthquake Analysis

Use real time data to locate and analyze earthquakes.



Waves in Action

Purpose

To observe waves created by a release of energy

Procedure

1. Hold the stir stick firmly in one hand and use the other hand to apply pressure on the stirrer until it begins to bend. Be careful not to break the stick.
2. Observe the stirrer as you release the pressure.
3. Record your observations in your science journal.
4. Fill the plastic tub with water.
5. Place the stirrer completely under the water and hold it with one hand on each end. Be careful not to move and allow time for the water to become smooth.
6. Bend the stirrer slowly until it breaks.
7. Observe and record.

Materials (per group)

paint stir stick
plastic tub
water
science journal

Conclusion

1. What happened to the stirrer when you released the pressure in step 2? Explain.
2. What happened to the water when the stirrer was broken? Why?
3. Research the elastic rebound theory and give a report to the class.

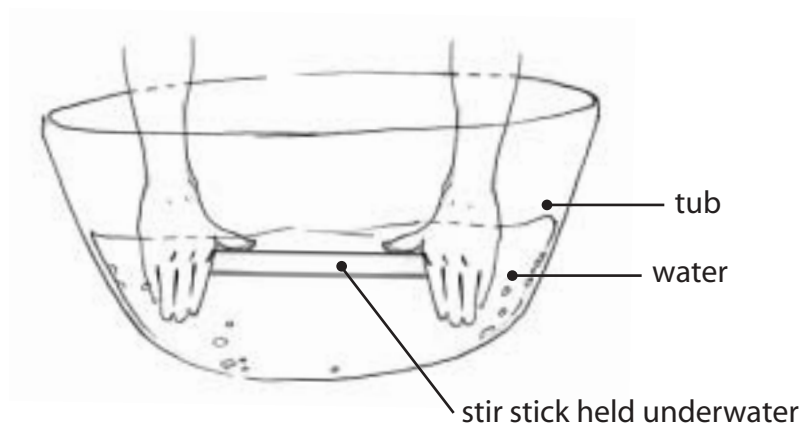

Have Wave Will Travel

Purpose

To demonstrate how P and S waves travel

Procedure

1. With your partner, stretch the Slinky® 2 meters.
2. To demonstrate a primary (P) wave, slowly pull the Slinky® toward you and then quickly push it away. See diagram 1.
3. Observe how the energy you released travels from you to your partner. Record your observations.
4. To demonstrate a secondary (S) wave, shake one end of the Slinky® up and down. See diagram 2.
5. Observe how the wave is traveling and record.
6. To demonstrate a horizontal secondary (S) wave, move the Slinky® from side to side. See diagram 3.
7. Observe and record.
8. To demonstrate a surface wave, push and pull the Slinky® at the same time that you move it up and down. Your hand should move in a circle. See diagram 4.

Materials

Slinky®
science journal
meter stick

Conclusion

1. Describe how the P and S waves differ.
2. According to Dr. D, which wave arrives first, second, last? Which wave does the most damage?
3. Conduct research to find out how waves are created and what happens to them as they travel away from the focus of an earthquake

Extension

1. Use a Venn diagram to compare and contrast the various waves.
2. Use a Newton's Cradle or make your own with marbles attached to string to demonstrate the push-pull of P waves.

Diagram 1

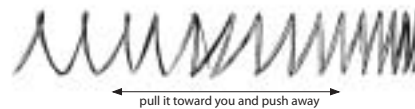

Diagram 2

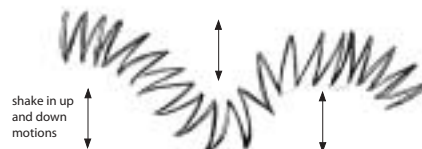
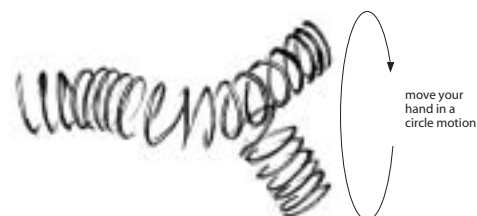

Diagram 3



Diagram 4



Sweet Waves

Purpose

To investigate the movement of waves

Procedure

1. Take the pan of prepared gelatin and place it on a flat surface.
2. The gelatin represents the crust of the Earth. Predict what would happen to the crust if an "earthquake" were to occur and record in your science journal.
3. Using a rubber mallet, create an earthquake by lightly tapping the side of the pan.
4. Observe and record the results in your science journal.
5. Tap the side of the pan harder and observe and record.
6. Place the plastic wrap on top of the gelatin.
7. Use the dominoes and sugar cubes to create buildings and other structures.
8. Predict what will happen when you strike the pan.
9. Now hit the side of the pan again and record the results.
10. Experiment with the placement and arrangement of the buildings and the amount of force you use to hit the side of the pan in order to change the results.
11. Once you have completed the activity, remove the plastic wrap and enjoy the edible crust.

Materials

metal tray of prepared gelatin
dessert
dominoes
sugar cubes
plastic wrap
rubber mallet
science journal

Conclusion

1. What happened when you tapped the pan harder?
2. What happened to the buildings on the surface? Why?
3. How could you make your buildings sturdier, so that they won't fall over?

Extension

1. Place popcorn kernels on top of a cereal box and gently tap the side of the box for five seconds. Stop and count the number of kernels that fell off. Repeat, tapping the box for ten seconds. Discuss the results.

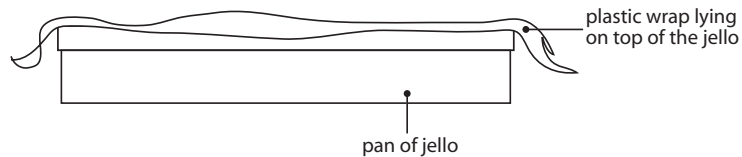

The Foolish Man Built His House Upon the Sand

Background

Liquefaction is a physical process that can take place during earthquakes and often leads to ground failure. Liquefaction is the term used to describe when a solid (in this case a soil) begins to act as a fluid. When dry sand is subjected to a force such as earthquake waves, the soil will become packed more tightly together, reducing its volume. The strength of the soil depends upon the friction between the sand particles. When sand contains water in the spaces between the sand particles, the strength of the soil is reduced. What has essentially happened is that the increased pressure of the water filling the spaces has reduced the friction between the soil particles. Since sand's shear strength is entirely dependent upon the internal friction (between the particles), the soil's strength is reduced or, in some cases, completely lost. When all the stress has been transferred to the water and maintained for a period of time, the soil behaves as a liquid. Since the soil is acting as a liquid, structures resting on it will sink or tilt. The amount they move will depend on how viscous the liquefied soil is and how long it remains liquefied (as well as other factors). If you have stepped on a piece of ground only to sink down past your foot, you have experienced liquefaction!

Materials

heavy plastic tub
sand
water
brick
rubber mallet
science journal

Purpose

To understand liquefaction and how it can cause the ground to become unstable during an earthquake

Procedure

1. Fill the tub 5 cm from the top with sand and spread it to form a flat, even surface.
2. Set the brick vertically on the sand surface and push it down to slightly anchor it.
3. Using the mallet, very gently tap the sides of the tub several times to create an "earthquake."
4. Observe what happens to the sand and the brick. Record in your science journal.
5. Slowly add water to the tub until the water just appears at the surface. Let the water be absorbed for a few minutes.
6. Using the mallet, repeat tapping the sides of the tub and observe what happens to the sand and the brick. Record your observations.

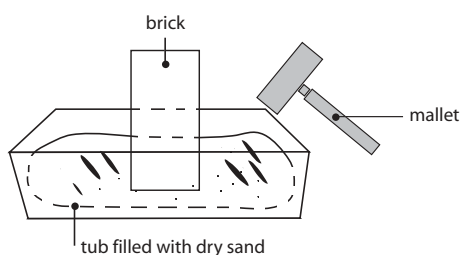

Diagram 1

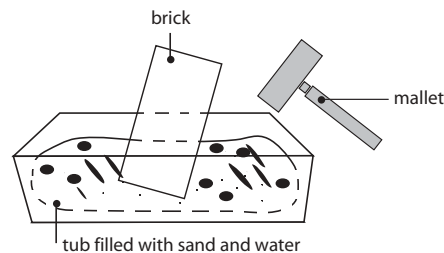

Diagram 2

The Foolish Man...(continued)

Conclusion

1. Explain what happened to the sand and the brick when the tub was tapped before adding the water?
2. Explain what happened to the sand and the brick after the water was added and the tub was tapped?
3. During an earthquake, what could happen to buildings on top of soil that was liquefied?

Extension

1. To help students understand that there is space between molecules, fill a jar full of marbles and ask the students if the jar is full. Add salt or sugar to the jar until "full" and repeat the question. Add water to the jar and repeat the question. Explain to students that even when things look tightly packed together, there is still space between molecules.
2. Read the following scenario and have each student take the role of a seismic engineer. Scenario: In the city of Kwiksands, the city council has decided to build a business park on several acres of land. As a seismic engineer hired to check out the land for safety measures, you have discovered that the ground in that area is highly permeated with water. You are responsible for writing a letter to the city council advising them of your findings and informing them of the risks involved in building on that land.
3. Research the threat of liquefaction to the San Francisco Bay area of California and other areas and create a report to share with the class.

California On the Move

Color the water light blue and the land brown in each of these pictures; then cut along the lines and assemble them into a flip book, with number 1 on top. Flip the pages to see a time-lapse movie of 50 million years of California's future.

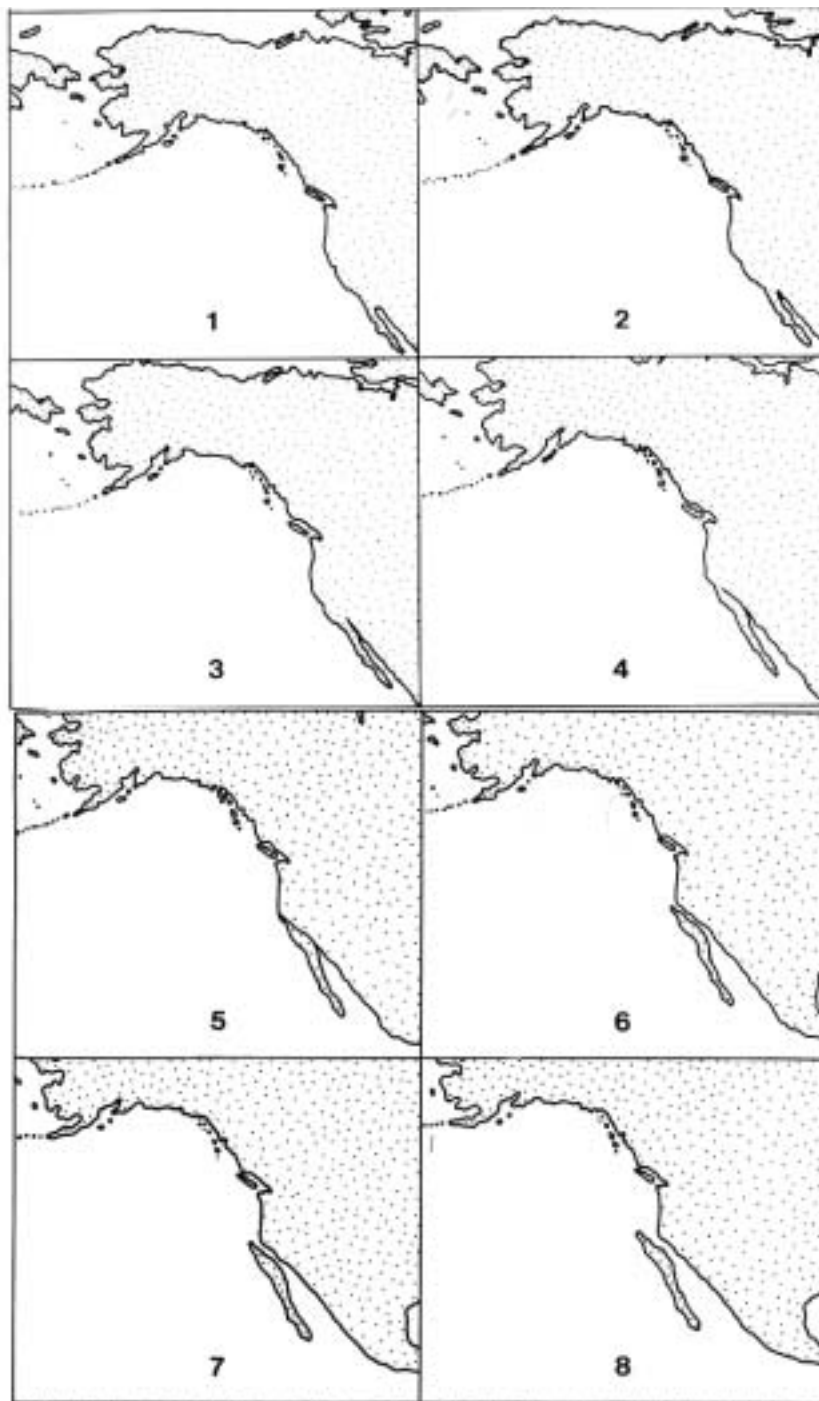

California On the Move (continued)

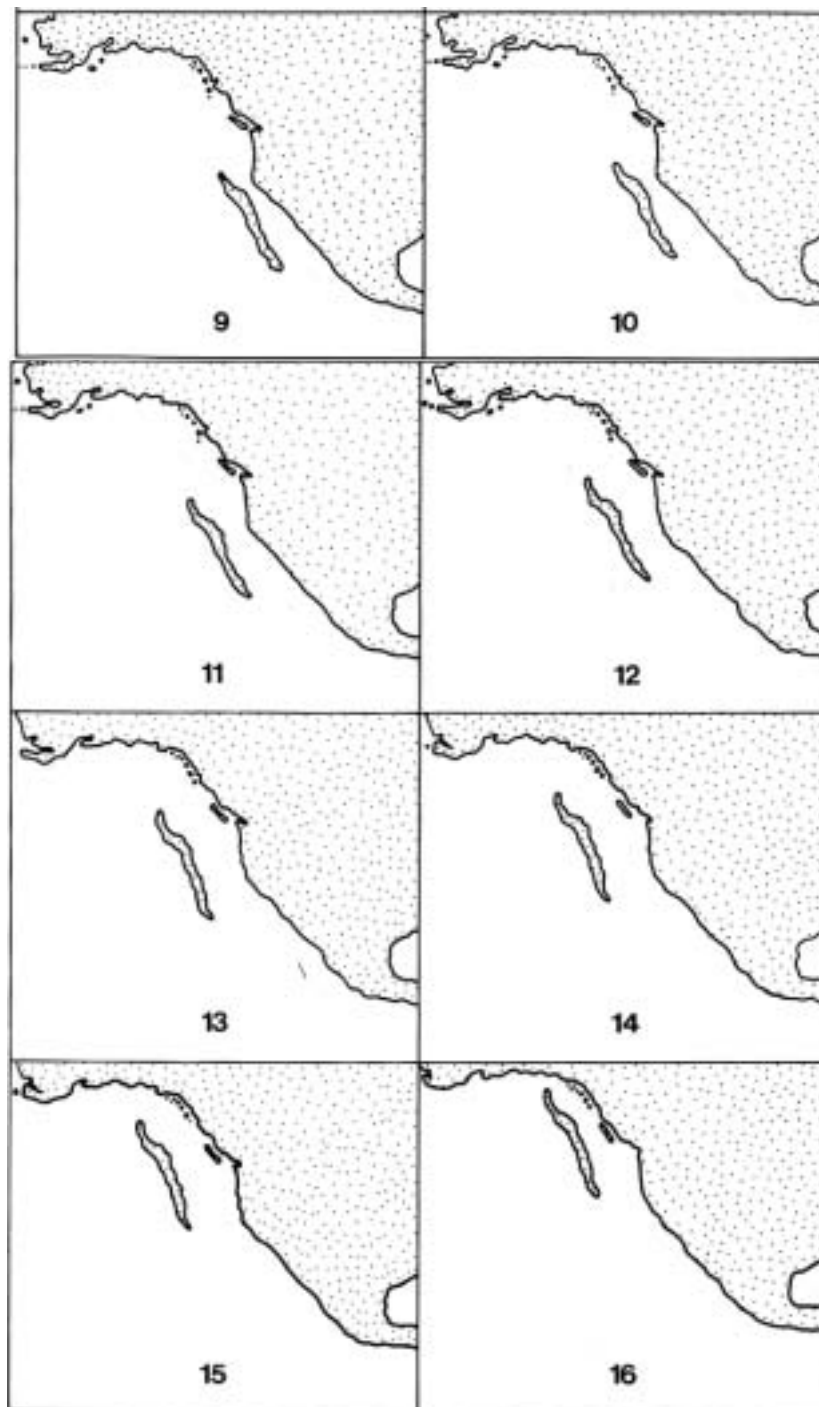

Answer Key

Waves in Action

1. When the pressure on the stirrer was released in step 2, the stirrer returned to its approximate original shape. When the stirrer was bent, energy was transferred from your hands to the stirrer. Once the pressure was released, the stirrer was able to return to its original position because the wood was flexible.
2. When the stirrer was bent, energy was transferred from your hands to the stirrer. The stirrer kept storing this energy until it broke. Once broken the energy was transferred to the water. Waves radiated from the breaking point of the stirrer, causing the water to become unsettled.
3. Reports will vary. This buildup and release of energy in the plates of the Earth is the foundation of the Elastic Rebound Theory.

Have Wave Will Travel

1. The P wave traveled back and forth along the same direction it was traveling. These are known as longitudinal or compression waves. With the S wave, the slinky moved up and down perpendicular to the direction that the wave was traveling. The horizontal S wave moved horizontally but also at right angles to the direction of the progressing wave.
2. The fastest moving wave is the P wave, then the S wave, and last the surface wave. Surface waves do the most damage.
3. An earthquake begins when stress on large blocks or rock becomes greater than the strength of the rock. The rock fractures, releasing vast amounts of energy. This energy is carried outward in all directions by various seismic waves, some of which can reach the opposite side of the Earth in about twenty minutes. The further the waves travel from the focus of the earthquake, the weaker they become.

Sweet Waves

1. The harder you tap the pan, the larger the waves.
2. The buildings and structures were knocked over and destroyed as you tapped the side of the pan. The larger the wave created, the more damage done. The waves made the structures move up and down and side-to-side making them unstable and imbalanced until they fell.
3. Answers will vary but might include that the structures need to be reinforced to withstand the motion created by the waves.

The Foolish Man Built His House Upon the Sand

1. The brick may have moved slightly in the earthquake, but the sand was strong enough to support the brick.
2. During this earthquake, the brick slowly sank into the moistened sand and probably tilted or toppled over.
3. The brick behaved like that of a tall building on mushy soil. When the soil liquefies, it cannot support the mass of the building and it simply falls down or collapses.

California On the Move

1. Answers will vary.
2. Answers will vary.
3. California experiences a lot of earthquakes because it is located on two plates sliding past one another. The sliding creates a lot of friction and stress over time. Eventually, the stress is released and earthquakes occur.
4. Reports will vary.

On the Web

Earthquake Analysis

- 1-3. Answers will vary as the information on the web site changes daily. Encourage students to look for patterns and correlations as they analyze the data.



The NASA SCI Files™
The Case of the
Shaky Quake

Segment 4

The tree house detectives continue their investigation into the cause of the tremor they felt in the tree house. Ruling out thunderstorms, they watch a Dr. Textbook segment on “Earth-shattering facts” and become even more determined to find the answer. Back in the tree house, the detectives dial up a NASA SCI Files™ Kids Club in Norfolk, Virginia to learn how the epicenter of an earthquake is located. Finally, the detectives head back to JPL to speak with Ron Baalke to learn about something totally unexpected and discover the answer to why they are “all shook up!”

Objectives

The students will

- locate the epicenter of an earthquake
- use triangulation to track a meteor's path to predict the location of meteorites.

- investigate meteor impacts on the Earth's surface.
- compare and contrast articles for fact and fiction.

Vocabulary

meteor—a meteoroid that enters Earth's atmosphere and burns up as it falls

meteorite—a meteor that reaches the Earth's surface

meteoroid—small pieces of rock that orbit the Sun, resulting from the breakup of comets

sonic boom—a sound, like that of an explosion, produced when a shock wave forms at the nose of an object traveling at supersonic speed reaches the ground

triangulation— the method in surveying of making measurements and using trigonometry to find where places are located on the Earth's surface using points whose exact location is known

Video Component

Implementation Strategy

The NASA SCI Files™ is designed to enhance and enrich the existing curriculum. Two to three days of class time are suggested for each segment to fully use video, resources, activities, and web site.

Before Viewing

1. Prior to viewing Segment 4 of *The Case of the Shaky Quake*, discuss the previous segment to review the problem and what the tree house detectives have learned thus far. Download a copy of the Problem Board from the NASA SCI Files™ web site and have students use it to sort the information learned so far.
2. Review the list of questions and issues that the students created prior to viewing Segment 3 and determine which, if any, were answered in the video or in the students' own research.
3. Revise and correct any misconceptions that may have been dispelled during Segment 3. Use tools located on the Web, as was previously mentioned in Segment 3.
4. Focus Questions-Print the questions from the web site ahead of time for students to copy into their science journals. Encourage students to take notes during the program to answer the questions. An icon will appear when the answer is near.

View Segment 4 of the Video

For optimal educational benefit, view *The Case of the Shaky Quake* in 15-minute segments and not in its entirety. If you are viewing a taped copy of the program, you may want to stop the video when the Focus Question icon appears to allow students time to answer the question.

After Viewing

1. At the end of Segment 4, lead students in a discussion of the focus questions for Segment 4.
2. Have students discuss and reflect upon the process that the tree house detectives used to solve the mystery of the tremor felt in the tree house. The following instructional tools located in the educator's area of the web site may aid in the discussion: Experimental Inquiry Process Flowchart and/or Scientific Method Flowchart.
3. Choose activities from the educator guide and web site to reinforce concepts discussed in the segment. Pinpoint areas in your curriculum that may need to be reinforced and use activities to aid student understanding in those areas. Educators can also search for resources by topic, episode, and media type under the Educator's main menu option *Resources*.



2001 – 2002 NASA Sci Files™ Programs

4. Wrap up the featured online Problem-Based Learning investigation. Evaluate the students' or team's final product generated to represent the online PBL investigation. Sample evaluation tools can be found in the educator's area of the web site under the main menu topic "Tools."
5. Have students write in their journals what they have learned about weather, hurricanes, and/or the problem-solving process and share their entry with a partner or the class.

Resources

Books

Boekhoff, P. M., Stuart A. Kallen, and Kris G. Hirschmann: *Meteors (Eyes on the Sky)*. Kidhaven, 2002, ISBN: 0737712899.

Morris, Neil: *Earthquakes*. Crabtree Publishing Company, 1998, ISBN 0865058326.

Petty, Kate: *I Didn't Know Tidal Waves Wash Away Cities*.

Copper Beech Books, 1999, ISBN 0761309225.

Prinja, Raman: *Comets, Meteors, and Asteroids (The Universe)*. Heinemann Library, 2002, ISBN: 1403406103.

Simon, Seymour: *Comets, Meteors, and Asteroids*. Mulberry Books, 1998, ISBN: 0688158439.

Walker, Sally M: *Earthquakes*. Carolrhoda Books, 1996, ISBN 0876148887.

Web Sites

Earthquakes in Illinois?

Visit this site to learn about the history of earthquakes in the New Madrid Fault System. Begin a web quest as a geologist and gather information on earthquakes.

<http://home.sullivan.k12.il.us/teachers/brunner/Earthquake.html>

Asteroid and Comet Impact Hazard

This NASA site is loaded with information about meteors. You can learn what they are, how they travel, and about the work being done by NASA

scientists in the field of meteors. You can even explore future missions such as Deep Impact where NASA plans on hitting a comet with a spacecraft and recording the contents of the comet.

<http://impact.arc.nasa.gov/>

American Red Cross

Do you know how to prepare for an earthquake? What to do when it happens and when its over? Check this site to learn how much you really know. <http://www.redcross.org/services/disaster/keepsafe/readyearth.html>

Tsunami!

This site focuses on the destructive power of these earthquake-spawned waves. It also includes the physics behind tsunamis and how humans are dealing with this major threat.

<http://www.geophys.washington.edu/tsunami/intro.html>

NASA's Observatorium

This site has information on plate tectonics and tsunamis. There are numerous other features such as games and other links.

<http://observe.arc.nasa.gov/nasa/core.shtml.html>

NASA Spacelink: Exploring Meteorite Mysteries

Go to this web site to download a PDF copy of Exploring Meteorite Mysteries. This educator guide for grades 5-12 provides information and activities related to meteorites and their origins, whether it be Mars, asteroids, or the Moon.

<http://spacelink.nasa.gov/products/Exploring.Meteorite.Mysteries/>

Careers

meteorologist
astronomer
physicist

Activities and Worksheets

In the Guide	Locating an Epicenter Use data from three seismic stations to find the epicenter of an earthquake.55
	Follow that Meteor! Learn to track the path of a meteor and predict where meteorites might be found.59
	Where Have All the Meteorites Gone? Create your own meteors and go on a meteorite hunt.60
	Shaky Word Find Locate earthquake related words in this word find.61
	Answer Key62
On the Web	Great Balls of Fire! Create your own craters to learn how meteors impact the Earth's surface.
	The Daily Shooting Star Read tabloid articles and use deductive reasoning to determine if they are fact or fiction.



Locating an Epicenter

Purpose To locate the epicenter of an earthquake

Background: An earthquake is any shaking or trembling of the Earth's crust. It is estimated that there are over 150,000 earthquakes around the world each year. However, only a few of them cause serious damage. The major cause of earthquakes is faulting, the sudden slipping or breaking of rocks beneath the Earth's surface. As the rocks break apart, the forces that have been acting upon them are relieved, causing a tremendous amount of energy to be released in the form of shock waves or vibrations. Some of the shock waves travel on the surface of the Earth and are called surface waves. The waves that travel through the body of the Earth are called Primary waves (P waves) and secondary waves (S waves). P waves can travel through solids, liquids, and gases, but S waves can travel only through solids. P waves are known to travel faster than S waves, but the speed of both P and S waves depends on the density of the rocks through which they travel. When the P and S waves reach the surface of the Earth, they set up new waves that travel along the surface of the Earth like ripples on a pond. These waves are called long waves (L waves). These surface waves are slower than the S and P waves, and they cause most of the damage and destruction to buildings.

Materials

drawing compass
paper

- Procedure**
1. Study the three sections of seismograms shown below in diagram 1.
 2. Each seismogram indicates the arrival time of the P waves and S waves of the same earthquake, as recorded in three different cities. Locate the arrival time of the P waves for each seismogram to the nearest 15 seconds and record in data chart 1 (p.56).
 3. Locate the arrival time of the S waves for each seismogram and record in data chart 1.
 4. Determine the difference, in minutes and seconds, between the arrival time of the P and S waves on each seismogram and record in data chart 1.

Diagram 1

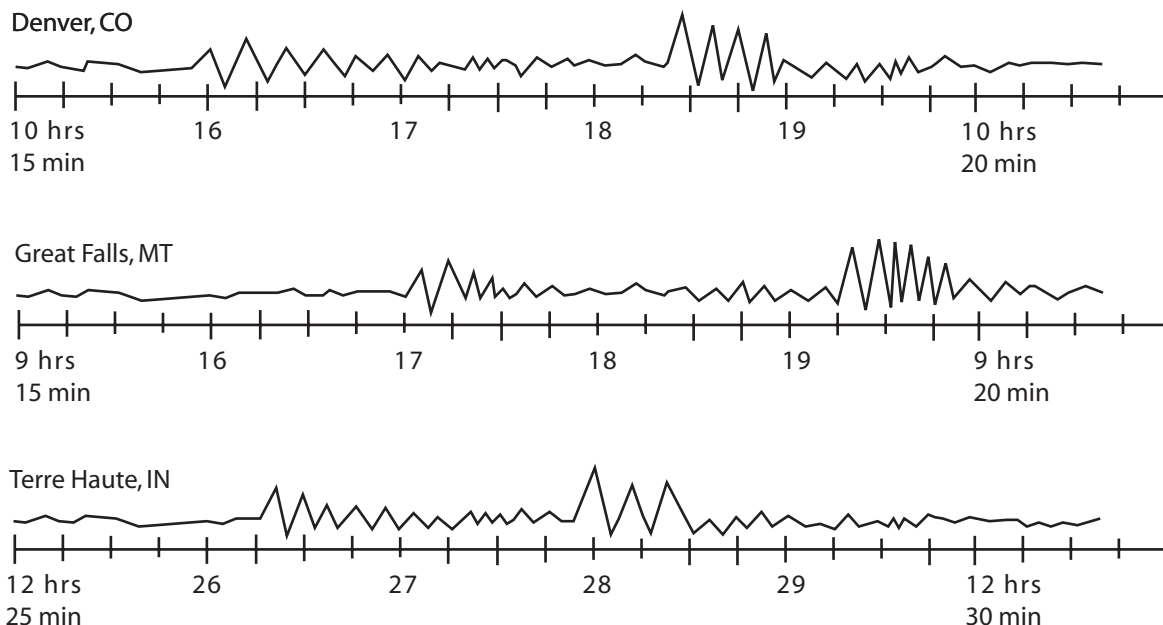

Locating an Epicenter (continued)

DATA CHART 1

Station	Arrival Time P Wave	Arrival Time S Wave	Difference in Time Of Arrival
Denver, CO			
Great Falls, MT			
Terre Haute, IN			

5. Look at the graph on p. 57 and answer the following:
 - a. What amount of time does each space on the vertical (y) axis represent?
 - b. How many kilometers does each space on the horizontal (x) axis represent?
 - c. How long does it take a P wave to travel 4,000 km from an epicenter?
 - d. How long does it take an S wave to travel 4,000 km from the same epicenter?
 - e. How much longer does it take an S wave to travel 4,000 km than a P Wave?
 - f. How much longer does it take an S wave to travel 5,000 km than a P wave?
 - g. In general, what happens to the difference in travel times as the distance increases?
 - h. What does any vertical distance between the P line and the S line on the graph represent?
6. Lay the edge of a small piece of paper along the vertical axis so that one end is even with the "0" coordinate. Mark off a distance on the edge of the paper that represents 3 minutes and 30 seconds (3:30).
7. Slide the marked paper along the P and S curves of the graph until the upper mark lies on the S curve, and the lower mark on the P curve. Be sure the edge of the paper lines up with the vertical lines of the graph.
8. According to the graph, how far from the epicenter does 3:30 represent?

DATA CHART 2

Station	Distance of Station From Epicenter
Denver, CO	
Great Falls, MT	
Terre Haute, IN	

9. To find the distance to the epicenter of the earthquake, repeat steps 6-8 for the three stations by using the "Difference in Time of Arrival" for each. Record in data chart 2.
10. Which city is the farthest from the epicenter?
11. Look at the map scale for the U.S. map (p. 58). Determine the distance that each small division on the scale represents. _____
12. Using the map scale, set your compass radius to the distance of the epicenter from Great Falls, MT. With this radius and Great Falls as the center, draw a circle on the map. The epicenter of the earthquake lies somewhere on this circle. Why can't its exact position be determined from this circle?
13. Repeat step 12, setting your compass for the radius for the distance of the epicenter from Denver. At how many points do the two circles intersect? _____
14. The epicenter must lie on one of these two points. Why?
15. Repeat step 12 for Terre Haute, IN. At how many points do the three circles intersect? _____ What does the point where they intersect represent? Explain.
16. Near what city shown on the map might the earthquake have occurred?



Locating an Epicenter

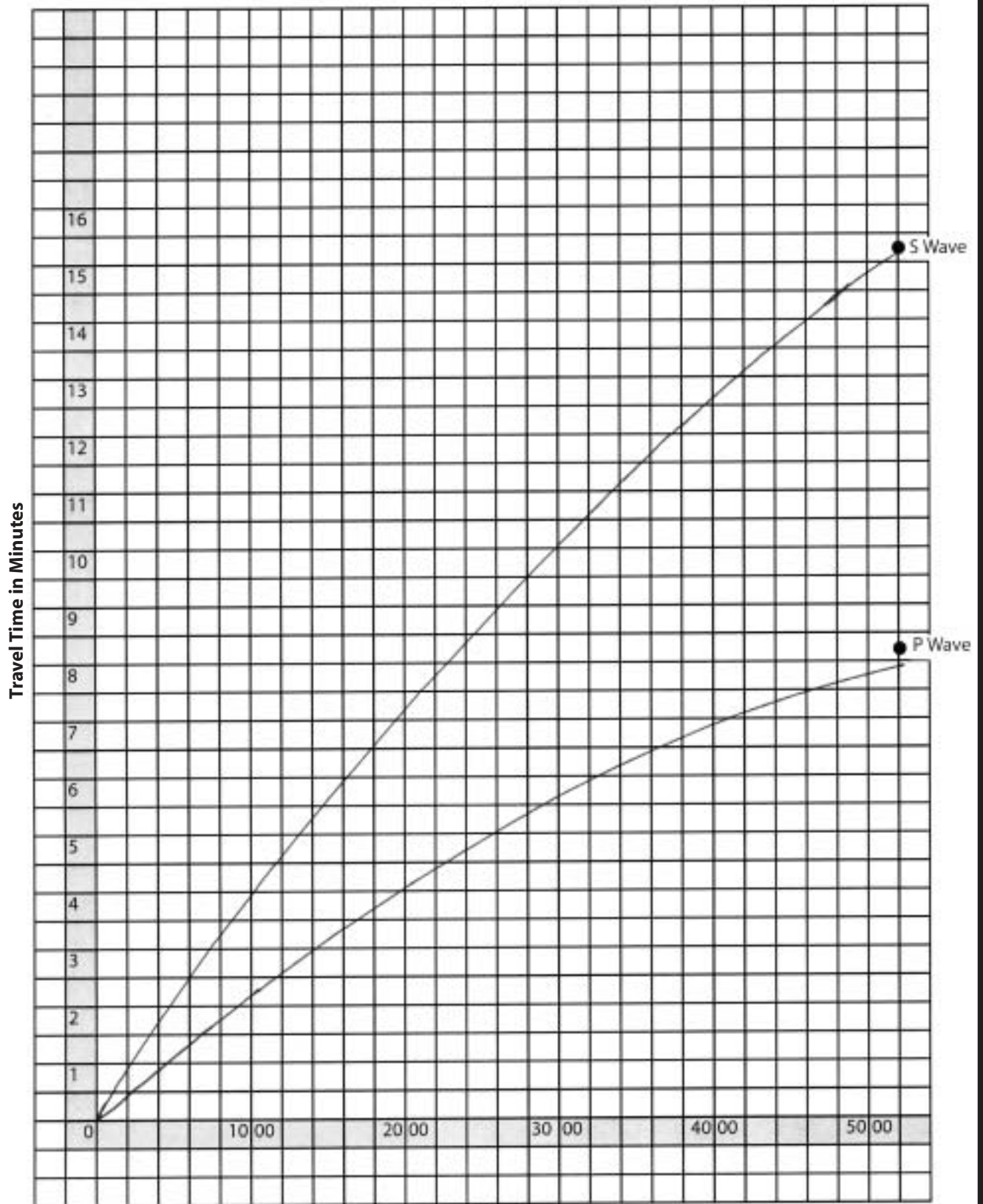

North America

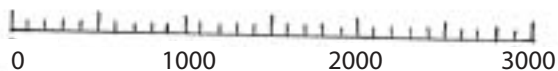
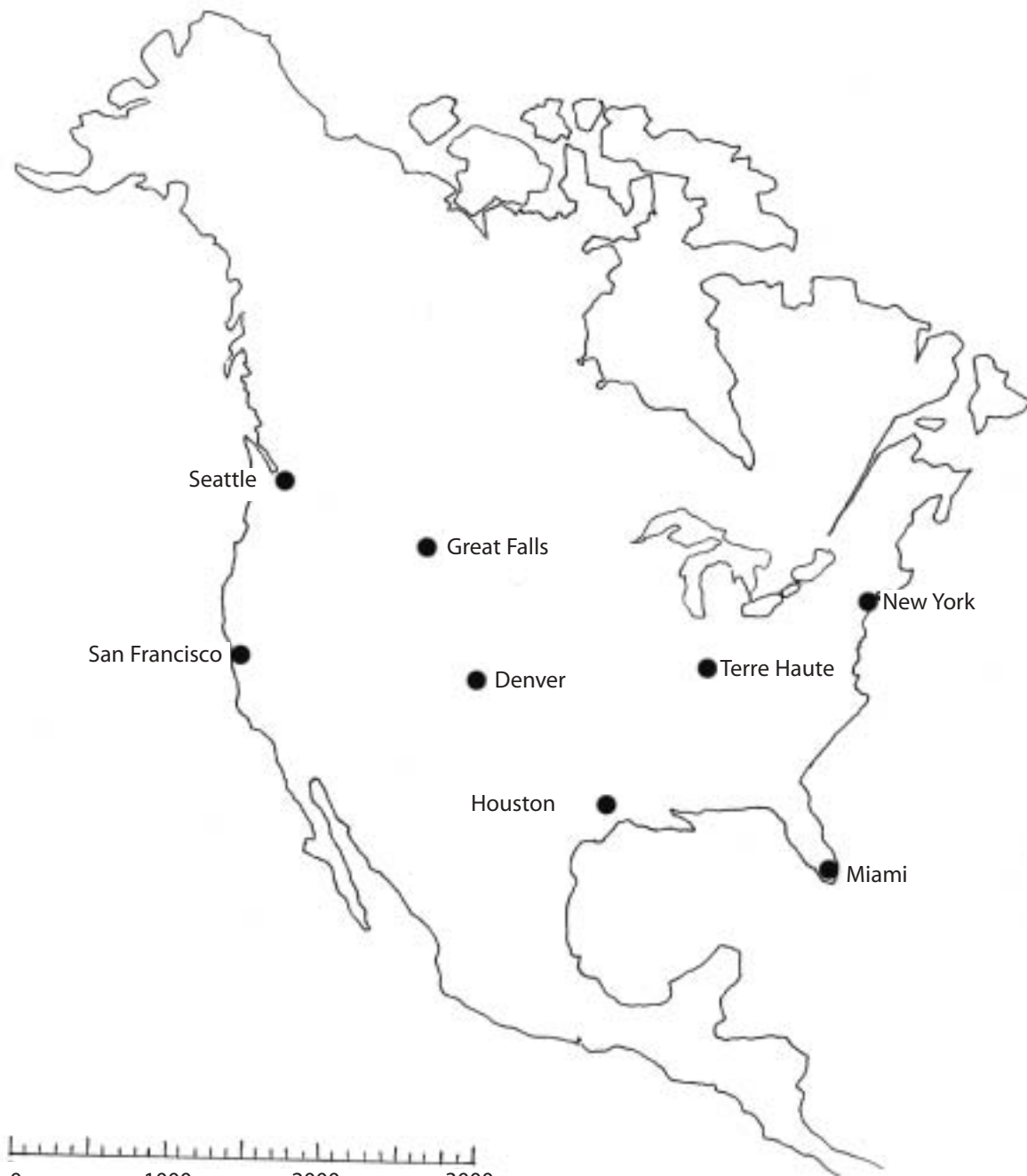

KILOMETERS

1000 km = 2.2 cm



Follow that Meteor!

Purpose

To use triangulation to track a meteor's path and to predict where meteorites might be found

Procedure

One clear starry night, two observers, Aric and Amber, were outside looking at the night sky. Even though they lived in different towns, they each saw a meteor streak across the sky. They both noticed a sudden "spark," and two seconds later there was an explosion. Eager to add meteorites to their rock collections, they decided that they needed to determine the path of the meteor at the time of the spark and where the meteor exploded. Aric lived in Drygulch Flats and Amber lived in Bubbling Bayou. Aric quickly e-mailed Amber and told her that he was looking 110° East of North when he saw the meteor spark and 80° East of North when it exploded. Amber said that she saw it spark at 60° East of North and it exploded at 40° East of North. Follow the directions below to help Aric and Amber find the location to begin looking for meteorites.

Materials

metric ruler
 protractor
 pencil
 colored pencils

1. On the map, locate the dashed line. Using the Compass Rose, determine which direction the line runs and record in your science journal.
2. Place your protractor along the dashed line so that the straight edge lines up evenly with the dashed line and the hole is centered over Drygulch Flats. Measure and mark an 80° angle.
3. With a colored pencil, draw a long line from Drygulch Flats through the mark you made.
4. Repeat steps 2-3 for Bubbling Bayou and mark a 40° angle with the same color pencil.
5. To calculate in km where the two lines intersect, use the map scale and a metric ruler.
6. Record in your science journal where the meteor exploded.
7. Using a different colored pencil, repeat steps 2-6 to determine where the meteor sparked.

Conclusion

1. Using the position of the spark and the explosion, which direction was the meteor traveling?
2. How far was it from where the meteor sparked to where it exploded?
3. Where would you first look for meteorites that might have fallen from the explosion? Is it guaranteed that Aric and Amber will find meteorites?
4. Using the formula $V = d/t$ estimate how fast the meteor was going in km/sec.

Bonus: determine the speed of the meteor in km/sec.
 Hint: Remember there are 60 minutes in an hour and 60 seconds in a minute.

Extension

1. Outside set up a meteorite hunt and give the students compass directions so that they learn to use a magnetic compass.
2. Place a ball bearing in a field to represent a meteorite. Provide a map of the field and triangulation observation angles. Have students attempt to find the "meteorite."

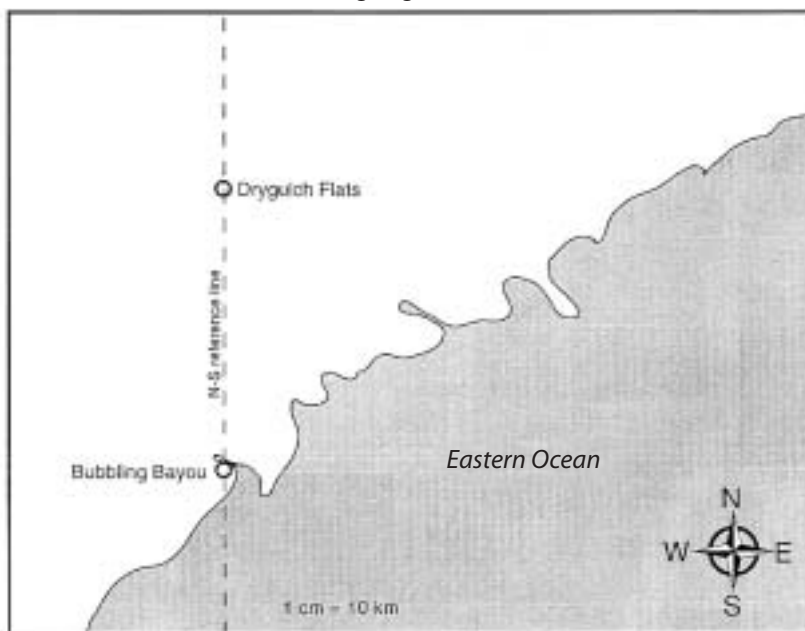

1 cm = 10 km

Where Have All the Meteorites Gone?

Purpose

To demonstrate the difficulty of locating meteorites

Teacher Note:

Locate several good areas around the school grounds such as concrete pavement, sandy area, or grassy field where this activity can be performed.

Procedure

1. Place a funnel in the neck of the balloon and fill balloon with approximately 0.1 liters (1/2 cup) of flour. Flour tends to pack, so it should be poured into the funnel slowly. Being careful not to puncture the balloon, use the skewer to keep the flour flowing if needed.
2. Add pebbles one at a time, noting number of pebbles and color. To tag your pebbles, write your initials with a marker on each one.
3. Fill the balloon 3/4 full with water. Do not shake the balloon and be sure to tie it securely.
4. Go outside to the areas designated to launch your balloon.
5. In your group, determine where and how each person will launch his/her balloon. Have each person throw his/her balloon differently, such as at an angle, lobbing it, or throwing it straight up so that it can impact vertically. Predict how many pebbles will be recovered from each launch.
6. After everyone in the group has thrown balloons, go to your impact site and sketch in your science journal the scatter pattern created by your balloon.
7. Try to locate as many of your original pebbles as possible.
8. Clean up all balloon fragments and leave the impact areas as clean as possible.
9. Make a graph of the percentage of pebbles recovered from each impact surface.

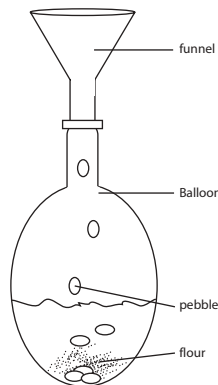

Diagram 1

Materials

balloon
0.1 liter of flour
10 to 20 small pebbles
water
funnel
metric measuring cup
skewer
graph paper
science journal

Conclusion

1. How did your data compare with your prediction for pebbles recovered?
2. Based on your data, which surface was the easiest for pebble recovery? Why?
3. Did the result match your prediction?
4. What kind of land surface might be most productive for searching for meteorites? Why?
5. How is the scatter pattern affected by the ground surface? By the angle of impact?
6. How might a scientist use this type of information to help locate meteorites?

Extension

1. Dramatize the impact and scatter pattern of pebbles by using students as pebbles and doing the dramatization in slow motion.
2. Vary the materials used in the balloons to add difficulty in locating the "meteorites."

Shaky Word Find

Word Bank

continental drift
crust
earthquake
fossil
epicenter

mantle
outer core
inner core
Pangaea
seismograph

tremor
plate tectonics
convergent
divergent
fault

focus
GPS
P waves
S waves
Richter

USGS
meteorite
meteoroid
sonic boom
meteor

O N C R U S T D S W A V E S P P A R A T U M
U N M O S P S M G P S A B E H A G U Y I N A
T A C E M O R P S W V C A C X N R O L M D N
E B F O T P E R U A K M E I C G I P E E C T
R N S A N E O M B V H T I H B A L C H T O L
C H E D L T O U A E R A U X S E L I S E N E
O K A I W O I R N S I N E T I A I I I O V E
R J I L I E S N O D C J I L P L L E U R E N
E L S T Y I D J E I B L S T R E M O R I R T
Z R E T H C I R E N D A I E S I R V A T G I
R E T N E C I P E I T E E T H S C A R E E E A
Q Z Q U I C K I A T H A M T F R T E P U N L
R N L D S H I N D P R I L T I S I I T I T L
Y G E A R S Z A A O V U O D R O N C Y A I I
K I V N R T S R T R A I D N R N E N H J K S
J S E Y K O G N Q F Y I Y I I I W N B O N S
H F R T J O E C R E O P E L L C F I I D A O
P E N E M G Y A E R T C K C I B A T S T R F
U E R S R G S I D K Z U U A E O I S H I C T
Y K I E I I T G A D T B I S B O L L I I I S
T E V E S B E K I S R I H Y O M J A C O N I
S I E M A I M O S C I N O T C E T E T A L P
D G W I N N E R C O R E I K K I N Y I R P V
O F A E A R T H Q U A K E L F U R O E T E M



Answer Key

Locating an Epicenter

DATA CHART 1

Station	Arrival Time P Wave	Arrival Time S Wave	Difference in Time of Arrival
Denver, CO	10hrs. 16min	10:18:30	2:30
Great Falls, MT	9:17:00	9:19:15	2:15
Terre Haute, IN	12:26:15	12:28:00	1:45

5. a. 30 seconds; b. 200 km; c. about 6 minutes and 45 seconds (6:45); d. 12 minutes and 30 seconds (12:30); e. 5 minutes and 45 seconds (5:45); f. 4 minutes and 30 seconds (4:30); g. the travel time increases; h. it represents the difference in travel time between the P and S waves

DATA CHART 2

Station	Distance of Station From Epicenter
Denver, CO	1600 km
Great Falls, MT	1400 km
Terre Haute, IN	1000 km

8. 2,400 km
10. Denver, CO
11. 100 km
12. This result only tells us how many miles it is from the epicenter. It could be this many miles in any direction.
13. 2
14. The intersections tell you that both of these points are the possible epicenter because they are both the correct distance from the epicenter.
15. 1; this point represents the epicenter. It is the only point that is the correct distance from all three stations.

Follow that Meteor!

- The meteor exploded 40-43 km east-northeast of Drygulch Flats (near where the two lines intersect.)
 - The meteor was 50-52 km northeast of Bubbling Bayou, or near the coastline by the peninsula.
1. north-northwest
 2. 23-25 km
 3. Aric and Amber should look for meteorites northeast of Drygulch Flats, near where the lines crossed on the map. There is no guarantee that there will be any meteorites because they could have all burned up before they reached the ground.

4. Approximately 11.5 to 12.5 km per second
Bonus: approximately 41,400 to 45,000 km per hour. The distance the meteor traveled in 2 seconds was 23-25 km. If you divide the distance by the time of 2 seconds, you get 11.5 and 12.5, respectively. To calculate how many km per hour the meteor was traveling, you must first know that there are 60 seconds in a minute and 60 minutes in an hour: 60 multiplied by 60 equals 3,600. Multiply 3,600 seconds (hour) by 11.5 and 12.5. The answer is 41,400 and 45,000 km per hour.

Where Have All the Meteorites Gone?

1. Answers will vary.
2. Answers will vary but might include surfaces that have no similar rocks, are very flat, have a contrasting background, and do not have thick vegetation.
3. Answers will vary.
4. Smooth, flat, contrasting surfaces would make locating meteorites the easiest. For example, meteorites are rarely found in forests or fields because they become lost or buried among the plants. In rocky areas, meteorites are hard to find because they tend to be the same color as Earth rocks. The best areas to find meteorites are at the polar ice cap in Antarctica and in deserts.
5. Answers will vary depending upon the surfaces and angles used.
6. After determining the angle of impact and the surface that the meteor struck, scientists look at scatter patterns created by similar impacts to help them determine where meteorites might be located after an impact.



Answer Key (continued)

Shaky Word Find

O N C R U S T D S W A V E S P P A R A T U M
 U N M O S P S M G P S A B E H A G U Y I N A
 T A C E M O R P S W V C A C X N R O L M D N
 E B F O T P E R U A K M E I C G I P E E C T
 R N S A N E O M B V H T I H B A L C H T O L
 C H E D L T O U A E R A U X S E L I S E N E
 O K A I W O I R N S I N E T I A I I I O V E
 R J I L I E S N O D C J I L P L L E U R E N
 E L S T Y I D J E I B L S T R E M O R I R T
 Z R E T H C I R E N D A I E S I R V A T G I
 R E T N E C I P E I T E E T H S C A R E E A
 Q Z Q U I C K I A T H A M T F R T E P U N L
 R N L D S H I N D P R I L T I S I I T I T L
 Y G E A R S Z A A O V U O D R O N C Y A I I
 K I V N R T S R T R A I D N R N E N H J K S
 J S E Y K O G N Q F Y I Y I I W N B O N S
 H F R T J O E C R E O P E L L C F I I D A O
 P E N E M G Y A E R T C K C I B A T S T R F
 U E R S R G S I D K Z U A E O I S H I C T
 Y K I E I I T G A D T B I S B O L L I I I S
 T E V E S B E K I S R I H Y O M J A C O N I
 S I E M A I M O S C I N O T C E T E T A L P
 D G W I N N E R C O R E I K K I N Y I R P V
 O F A E A R T H Q U A K E L F U R O E T E M

On the Web

Great Balls of Fire!

1. The craters were all similar in shape but differed in size. The heaviest object created the largest crater (diameter).
2. When the drop height was increased, the crater diameter also increased. The higher the balls were dropped, the greater the impact.
3. Answers will vary.

The Daily Shooting Star

1. Amateur Astronomer Discovers Comet—True
2. Annihilation Narrowly Avoided—True
3. Intelligence Enhancing Meteorites—False
4. Extraterrestrials Hurl Rock at Earth—False
5. Longevity Secret Revealed—False
6. Giant Impact Thought to Cause Mass Extinction—True
7. Huge Diamond Discovered in Meteorite—False
8. History of Solar System Revealed—True
9. Oldest Meteorite Found—True
10. Phenomenal New Energy Resources Discovered—False
11. Microbes from Mars—True

