



National Aeronautics and
Space Administration

Langley Research Center
Hampton, VA 23681-2199

Educational Product	
Educators	Grades 3-5

EG-2002-04-LARC

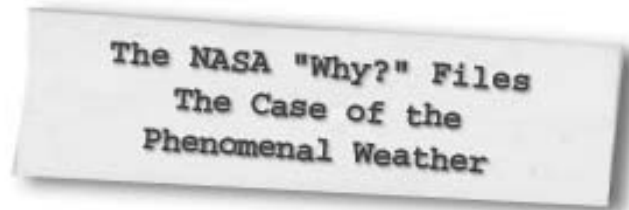

**A Lesson Guide with Activities in
Mathematics, Science, and Technology**



The Case of the Phenomenal Weather lesson guide is available in electronic format through NASA Spacelink - one of NASA's electronic resources specifically developed for the educational community. This publication and other educational products may be accessed at the following address: **<http://spacelink.nasa.gov/products>**

A PDF version of the lesson guide for NASA "Why?" Files can be found at the NASA "Why?" Files web site: **<http://whyfiles.larc.nasa.gov>**

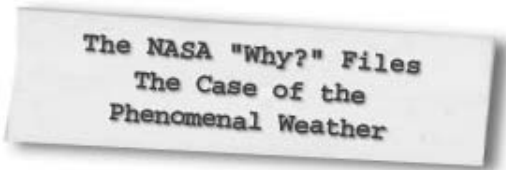

A Lesson Guide with Activities in Mathematics, Science, and Technology

Program Overview5
 National Geography Standards5
 National Science Standards6
 National Mathematics Standards.....8
 National Technology Standards9

Segment 1

Overview11
 Objectives12
 Vocabulary12
 Video Component.....12
 Careers.....13
 Resources14
 Activities and Worksheets15

Segment 2

Overview25
 Objectives26
 Vocabulary26
 Video Component.....26
 Careers.....27
 Resources28
 Activities and Worksheets28

Segment 3

Overview39
 Objectives40
 Vocabulary40
 Video Component.....40
 Careers.....41
 Resources41
 Activities and Worksheets42

Segment 4

Overview51
 Objectives52
 Vocabulary52
 Video Component.....52
 Careers.....53
 Resources53
 Activities and Worksheets54

For additional information about the NASA "Why?" Files, contact Shannon Ricles at (757) 864-5044 or e-mail s.s.ricles@larc.nasa.gov.

Production of the NASA "Why?" Files is made possible by the generous support provided by AIAA Foundation; Busch Gardens, Williamsburg; Hampton City Public Schools; and the NASA Langley Research Center's Learning Technology Project and Aerospace Vehicle Systems Technology Program Office.

Writer and Teacher Advisors: Shannon Ricles, Dan Green, and Paul Flach

Editor: Susan Hurd

 Registered users of the NASA "Why?" Files may request an American Institute of Aeronautics and Astronautics (AIAA) classroom mentor. For more information or to request a mentor, e-mail nasawhyfiles@aiaa.org.



Program Overview

The tree house detectives are eager to go to the physics fair at Busch Gardens, but they are worried that bad weather will keep them from attending. Just off the coast of Africa is a tropical wave, and even though it looks really far away, they decide they need to learn more about weather forecasting just to make sure. They are glad they made that decision when they find out that even more is at stake as KSNN announces the winners of the environmental contest. They won!

As the tree house detectives set out to become amateur meteorologists, they visit NASA's S'COOL project and learn that clouds are not as simple as they thought. As the storm begins to strengthen in the Atlantic Ocean, they decide to visit Dr. D, a retired science professor, who offers them a few pointers about air pressure, predicting, probability, and forecasting. However, the storm continues to

grow, and they know that it is time to speak to hurricane experts. They visit Dr. Lyons with the Weather Channel, the Hurricane Hunters, and NOAA (National Oceanic and Atmospheric Administration). They also get firsthand advice about hurricanes from a family in Miami who actually lived through Hurricane Andrew.

As the story continues, the storm develops into Hurricane Ichabod, a Category II hurricane. The tree house detectives seek help from a NASA "Why?" Files Kids Club at Thompson Elementary in Vero Beach, Florida who are playing the Hurricane Game. The class helps the tree house detectives learn more about hurricane watches and warnings and how to predict landfall. Join the tree house detectives to find out how the wind will blow and if they will get to go on their trip to Florida or if they had better stay home in Virginia!

National Geography Standards (grades 3-5)

Standard	Segment			
	1	2	3	4
The geographically informed person knows and understands				
The World in Spatial Terms				
How to use maps and other graphic representations, tools, and technologies to acquire, process, and report information from a spatial perspective	x	x	x	x
Places and Regions				
That people create regions to interpret Earth's complexity	x	x	x	x
Physical Systems				
The physical process that shapes the patterns of Earth's surface	x	x	x	x
Environment and Society				
How physical systems affect human systems	x	x	x	x
Uses of Geography				
How to apply geography to interpret the past				x
How to apply geography to interpret the present and plan for the future				x



National Science Standards (Grades K – 4)

Standard	Segment			
	1	2	3	4
Unifying Concepts and Processes				
Systems, orders, and organization	X	X	X	X
Evidence, models, and explanations	X	X	X	X
Change, constancy, and measurement	X	X	X	X
Evolution and equilibrium	X	X	X	X
Form and function	X	X	X	X
Science and Inquiry (Content Standard A)				
Abilities necessary to do scientific inquiry	X	X	X	X
Understanding about scientific inquiry	X	X	X	X
Physical Science (Content Standard B)				
Properties of objects and materials	X	X	X	X
Position and motion of objects	X	X	X	X
Light, heat, electricity, and magnetism	X	X	X	X
Earth and Space Science (Content Standard D)				
Properties of Earth materials	X	X	X	X
Objects in the sky	X	X	X	X
Changes in Earth and sky	X	X	X	X
Science and Technology (Content Standard E)				
Abilities of technological design	X	X	X	X
Understanding about science and technology	X	X	X	X
Ability to distinguish between natural objects and objects made by human beings	X	X	X	X
Science in Personal and Social Perspective (Content Standard F)				
Personal health	X	X	X	X
Changes in environment	X	X	X	X
Science and technology in local challenges	X	X	X	X
History and Nature of Science (Content Standard G)				
Science as a human endeavor	X	X	X	X



National Science Standards (Grades 5 - 8)

Standard	Segment			
	1	2	3	4
Unifying Concepts and Processes				
Systems, order, and organization	X	X	X	X
Evidence, models, and explanations	X	X	X	X
Change, constancy, and measurement	X	X	X	X
Evolution and equilibrium	X	X	X	X
Form and function	X	X	X	X
Science as Inquiry (Content Standard A)				
Abilities necessary to do scientific inquiry	X	X	X	X
Understanding about scientific inquiry	X	X	X	X
Physical Science (Content Standard B)				
Properties and changes of properties in matter	X			
Motion and forces	X	X	X	X
Transfer of energy	X	X	X	X
Earth and Space Science (Content Standard D)				
Structure of the Earth system	X	X	X	X
Science and Technology (Content Standard E)				
Abilities of technological design	X	X	X	X
Understanding about science and technology	X	X	X	X
Science in Personal and Social Perspectives (Content Standard F)				
Natural hazards	X	X	X	X
Risks and benefits	X	X	X	X
Science and technology in society	X	X	X	X
History and Nature of Science (Content Standard G)				
Science as a human endeavor	X	X	X	X
Nature of science	X	X	X	X



National Mathematics Standards (Grades 3 - 5)

Standard	Segment			
	1	2	3	4
Number and Operations				
Compute fluently and make reasonable estimates.			X	X
Algebra				
Use mathematical models to represent and understand quantitative relationships.	X	X	X	X
Geometry				
Specify location and describe spatial relationships using coordinate geometry and other representational systems.	X	X	X	X
Measurement				
Understand measurable attributes of objects and the units, systems, and processes of measurement.	X			X
Apply appropriate techniques, tools, and formulas to determine measurements.	X			X
Data Analysis and Probability				
Formulate questions that can be addressed with data and collect, organize, and display relevant data to answer them.	X	X	X	X
Select and use appropriate statistical methods to analyze data.	X	X	X	X
Develop and evaluate inferences and predictions that are based on data.	X	X	X	X
Understand and apply basic concepts of probability.	X	X	X	X
Problem Solving				
Solve problems that arise in mathematics and in other contexts.	X	X	X	X
Apply and adapt a variety of appropriate strategies to solve problems.	X	X	X	X
Monitor and reflect on the process of mathematical problem solving.	X	X	X	X
Communication				
Analyze and evaluate the mathematical thinking and strategies of others.				X
Connections				
Recognize and use connections among mathematical ideas.				X
Recognize and apply mathematics in contexts outside mathematics.				X
Representation				
Create and use representations to organize, record, and communicate mathematical ideas.	X	X	X	X
Use representations to model and interpret physical, social, and mathematical phenomena.	X	X	X	X



National Technology Standards (ITEA Standards for Technology Literacy, Grades 3 – 5)

Standard	Segment			
	1	2	3	4
Nature of Technology				
Standard 1: Students will develop an understanding of the characteristics and scope of technology.	X	X	X	X
Standard 2: Students will develop an understanding of the core concepts of technology.	X	X	X	X
Standard 3: Students will develop an understanding of the relationships among technologies and the connections between technology and other fields of study.	X	X	X	X
Technology and Society				
Standard 4: Students will develop an understanding of the cultural, social, economic, and political effects of technology.	X	X	X	X
Standard 5: Students will develop an understanding of the effects of technology on the environment.	X	X	X	X
Standard 6: Students will develop an understanding of the role of society in the development and use of technology.	X	X	X	X
Standard 7: Students will develop an understanding of the influence of technology on history.				X
Abilities for a Technological World				
Standard 12: Students will develop abilities to use and maintain technological products and systems.	X	X	X	X
The Designed World				
Standard 17: Students will develop an understanding of and be able to select and use information and communication technologies.	X	X	X	X



National Technology Standards (ISTE National Educational Technology Standards, Grades 3 - 5)

Standard	Segment			
	1	2	3	4
Basic Operations and Concepts				
Use Keyboards and other common input and output devices efficiently and effectively.	X	X	X	X
Discuss common uses of technology in daily life and the advantages and disadvantages those uses provide.	X	X	X	X
Social, Ethical and Human Issues				
Discuss common uses of technology in daily life and the advantages and disadvantages those uses provide.	X	X	X	X
Discuss basic issues related to responsible use of technology and information and describe personal consequences of inappropriate use.	X	X	X	X
Technology Productivity Tools				
Use general purpose productivity tools and peripherals to support personal productivity, remediate skill deficits, and facilitate learning throughout the curriculum.	X	X	X	X
Use technology tools for individual and collaborative writing, communication, and publishing activities to create knowledge products for audiences inside and outside the classroom.	X	X	X	X
Technology Communication Tools				
Use technology tools for individual and collaborative writing, communication, and publishing activities to create knowledge products for audiences inside and outside the classroom.	X	X	X	X
Use telecommunication efficiently and effectively to access remote information, communicate with others in support of direct and independent learning, and pursue personal interests.	X	X	X	X
Use telecommunication and online resources to participate in collaborative problem-solving activities for the purpose of developing solutions or products for audiences inside and outside the classroom.	X	X	X	X
Technology Research Tools				
Use telecommunication and online resources to participate in collaborative problem-solving activities for the purpose of developing solutions or products for audiences inside and outside the classroom.	X	X	X	X
Use technology resources for problem solving, self-directed learning, and extended learning activities.	X	X	X	X
Determine when technology is useful and select the appropriate tools and technology resources to address a variety of tasks and problems.	X	X	X	X
Technology Problem-Solving and Decision-Making Tools				
Use technology resources for problem solving, self-directed learning, and extended learning activities.	X	X	X	X
Determine when technology is useful and select the appropriate tools and technology resources to address a variety of tasks and problems.	X	X	X	X



The NASA "Why?" Files
The Case of the
Phenomenal Weather

Segment 1

The tree house detectives are eager to go to the upcoming physics fair at Busch Gardens. Last year the fair was rained out, and they are hoping that the weather does not spoil the fun this year. They decide that they had better learn more about weather. Clouds seem to be the place to start, so the tree house detectives visit Dr. Lin Chambers at NASA Langley Research Center in Hampton, VA. They decide that they might need to know a little more about weather and they head to Dr. D's lab. Dr. D explains to the tree house detectives that the Sun is the driving force in weather and tells how air pressure plays an important role. While in the lab, the tree house detectives hear a weather update and learn that a tropical wave off the African coast has become a tropical depression. Now they have to worry not only about the physics fair but also their possible trip to Florida!

Objectives

The students will

- understand that weather changes from day to day.
- learn that water can be changed from one state to another by heating or cooling.
- learn that clouds affect weather and climate.
- understand the water cycle.
- learn the three main types of clouds.
- understand that the Sun is a major source of energy for weather.
- understand air pressure.
- learn that heat moves in predictable ways, flowing from warmer objects to cooler ones.
- learn how wind is created.
- learn how different environments support different organisms.
- understand that animals and plants need to adapt to survive.

Vocabulary

air pressure - measure of the force of air pressing down on the Earth's surface

cirrus - a thin white cloud usually of tiny ice crystals formed at altitudes of 6,000 to 12,000 meters

cumulus - a large cloud form having a flat base and rounded outlines often piled up like a mountain

condense - to make or become closer, more compact, concise, or dense

eye of a hurricane - the center of the hurricane that has low pressure and calm winds

particles - one of the very small parts of matter

physics - a science that deals with matter and energy and their actions upon each other in the fields of mechanics, heat, light, electricity, sound, and the atomic nucleus

prevailing wind - wind that blows more often from one direction than from any other direction

tropical depression - a tropical cyclone with maximum sustained winds less than 39 mph

tropical wave - a trough or cyclonic curvature maximum in the trade wind easterlies

tropics - tropical climate zone located between 30° latitude and the equator (0°) in each hemisphere

stratus - a cloud form extending over a large area at an altitude from 600 to 2100 meters

water vapor - water in a gaseous form, especially when below boiling temperature and when spread through the atmosphere

Video Component

Implementation Strategy

The NASA "Why?" Files is designed to enhance and enrich the existing curriculum. Two to three days of class time is suggested for each segment to fully use video, resources, activities, and the web site.

Before Viewing

1. Prior to viewing Segment 1 of *The Case of the Phenomenal Weather*, read the program overview (p. 5) to the students. List and discuss questions and preconceptions that students may have

about weather, hurricanes, and tornadoes.

2. Record a list of issues and questions that the students want answered in the program. Determine why it is important to define the problem before beginning. From this list, guide students to create a class or team list of three issues and four questions that will help them better understand the problem. The following tools are available on the web site to assist in the process.

Problem Board - Printable form to create student or class K-W-L chart



PBL Questions - Questions for students to use while conducting research

Problem Log - Printable log for students with the stages of the problem-solving process

The Scientific Method - Chart that describes the scientific method process

3. Focus Questions - Questions at the beginning of each segment help students focus on a reason for viewing. These can be printed from the web site ahead of time for students to copy into their science journals. Encourage students to take notes during the program to answer the questions. An icon will appear when the answer is near.
4. What's Up? Questions - Questions at the end of the segment help students predict what actions the tree house detectives should take next in the investigation process and how the information learned will affect the case. These can be printed from the web site ahead of time for students to copy into their science journals.

Careers

physicist
weather forecaster
atmospheric scientist
reporter
cloud-seeding expert
researcher
solar astronomer
hydrologist

View Segment 1 of the Video

For optimal educational benefit, view *The Case of the Phenomenal Weather* in 15-minute segments and not in its entirety. If you are viewing a taped copy of the program, you may want to stop

the video when the Focus Question icon appears to allow students time to answer the question.

After Viewing

1. Have students reflect on the "What's Up?" questions asked at the end of the segment.
2. Discuss the Focus Questions.
3. Students should work in groups or as a class to discuss and list what they know about weather and tropical storms. As a class, reach a consensus on what additional information they need to know about weather and tropical storms before they can predict whether the tree house detectives will be attending the physics fair. Have the students conduct independent research or provide students with the information needed.
4. Have the students complete Action Plans, which can be printed from the web site, and then conduct independent or group research using books and internet sites noted on the Research Rack section of the NASA "Why?" Files web site. Educators can also search for resources by topic, episode, and media type under the Educator's main menu option Resources.
5. Choose activities from the educator guide and web site to reinforce concepts discussed in the segment. The variety of activities is designed to enrich and enhance your curriculum. Activities may also be used to help students "solve" the problem along with the tree house detectives.
6. Have the students work individually, in pairs, or in small groups on the Problem-Based Learning (PBL) activity on the NASA "Why?" Files web site.
7. To begin the PBL activity, read the scenario to the students.
8. Read and discuss the various roles involved in the investigation. Have each student choose his/her role.
9. Print the criteria for the investigation and distribute.
10. Have students use the Research Rack located on the web site and the online tools that are available.
11. Having students reflect in their journals what they have learned from this segment and from their own experimentation and research is one way to assess the students. In the beginning, students may have difficulty reflecting. To help students, give them specific questions that are related to the concepts to reflect upon.
12. Have students complete a Reflection Journal, which can found in the Problem-Solving Tool section of the online PBL investigation or in the Instructional Tools section of the Educator's area.
13. The NASA "Why?" Files web site provides educators with general and specific evaluation tools for cooperative learning, scientific investigation, and the problem-solving process.

Resources (additional resources located on web site)

Books

Allen, David: *Air: All About Cyclones, Rainbows, Clouds, Ozone and More*. Greey de Pencier Books, 1993, ISBN: 1895688086.

De Paola, Tommie: *The Cloud Book*. Holiday House, 1985, ISBN: 0823405311.

Edom, Helen and Moira Butterfield: *Usborne Science Activities: Science with Air*. Usborne Publishing Ltd., 1991, ISBN: 0746009720.

Gibbons, Gail: *Weather Forecasting*. Aladdin Paperbacks, 1993, ISBN: 0689716834.

Kahl, Jonathan D.: *National Audubon Society First Field Guide Weather (National Audubon First Field Guide)*. Scholastic Trade, 1998, ISBN: 0590054880.

Simon, Seymour: *Weather*. Harpercollins Juvenile Books, 2000, ISBN: 068817521X.

Videos

Eyewitness: Weather. ASIN: 6304165331

Web Sites

S'COOL

Official NASA web site for the Students' Cloud Observations On-Line Project. Register your class to help NASA gather real-time data to study clouds and the atmosphere. Resources are available for both students and teachers.

<http://asd-www.larc.nasa.gov/SCOOL/>

The Weather Channel

Check your local forecast or the weather across the country. Explore "Weather in the Classroom" and find great resources for you and your students.

<http://www.weather.com>

The Weather Unit

This site is a complete unit on weather and related activities in math, science, art, music, social studies and more.

<http://faldo.atmos.uiuc.edu/WEATHER/weather.html>



Activities and Worksheets

In the Guide	Particular Particles Learn how particles help water vapor to condense	16
	It's Time to Get Cirrus with Clouds! Make models of different cloud types	17
	Altitude Chart	18
	Cloud Chart	19
	Cyclical Cycles Learn how water can be changed from one state to another by heating and cooling ..	20
	Putting on the Pressure Make a simple aneroid barometer to use in class or at home	21
	Convection to Perfection Learn that heat moves in predictable ways	22
	Windy Wind Learn how wind is created	22
	Answer Key	24
On the Web	Nice Angle Learn how the Sun's angle affects the temperature on Earth	
	Invisible Weight An activity to help you understand that air has weight	



Particular Particles

Purpose

To learn that water vapor condenses around particles in the sky to form clouds

Procedure

1. Fill the pan with .5 cm of water.
2. Put the eraser in the middle of the pan.
3. Place approximately 10 salt grains onto the eraser.
4. Put the drinking glass over the eraser so that the mouth of the glass is resting on the pan.
5. Observe the salt grains every 5 minutes for a total of 20 minutes.

Conclusion

1. What happened to the salt grains?
2. How did the water droplets get from the pan to the salt grains?
3. Based on your results from this activity, what could you predict is in the atmosphere that makes cloud formation possible?

Extension

Find a window where the sun is coming through. Look closely for tiny particles floating around in the stream of sunlight.

Materials

rectangular pan
small drinking glass
with a large mouth
large rectangular
pencil eraser
table salt
tap water

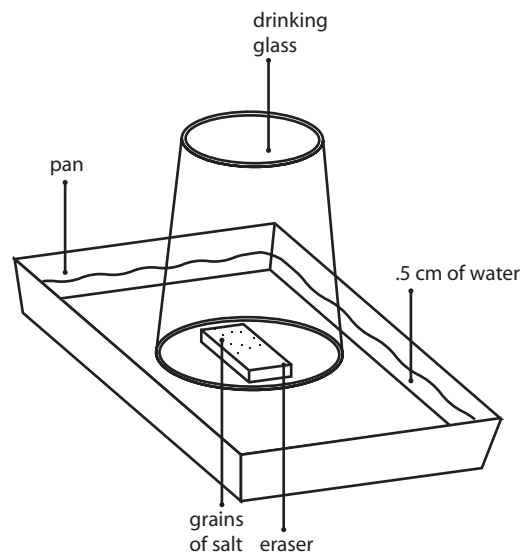

It's Time to Get Cirrus with Clouds!

Clouds come in many shapes and sizes, but all clouds are made up of billions of tiny water drops or ice crystals. Air cools when it rises through the atmosphere. If it cools enough, water vapor in the air condenses to form clouds. There are three basic types of clouds – wispy “cirrus” clouds, fluffy-white-heaped “cumulus” clouds, and huge blanket layers of “stratus” clouds.

Luke Howard (1772-1864), an English scientist, was the person who devised the classification of clouds we use today. Since Latin was the language of science at that time, Howard used Latin words that best described the shape of the clouds. For example, cirrus means “curl of hair,” cumulus means “heap,” and stratus means “layer.”

Clouds are also identified by how high in the sky they are. For example, “cirro-” means high, “alto-” means medium, and “nimbo-” means low. Meteorologists use a combination of cloud type and altitude to name most clouds; so, altocumulus clouds, for instance, are fluffy cumulus clouds at a medium-high altitude.

Materials

altitude chart (p. 18)
cloud chart (p. 19)
cotton balls
sheet cotton
glue
black felt-tip marker
dark colored
construction paper

Purpose To make models of different cloud types

Procedure

1. Use the cloud and altitude charts as guides for creating clouds. Students may want to transfer the altitude numbers onto the construction paper.
2. Make various types of clouds by gluing different amounts of cotton onto the construction paper. Here are some tips to get started:
3. Pulling the cotton into thin, wispy strands can make cirrus clouds.
4. To make a cumulus cloud, puff up a ball of cotton and paste it on the paper.
5. For a stratus cloud, cut off a piece from the sheet cotton, pull the layers apart, and glue it to the paper.
6. Use the black marker to turn some clouds into nimbus precipitation clouds.
7. Using the completed cloud models and cloud chart as a reference, identify the types of clouds that are in the sky today.

Conclusion





1. Which cloud types are the highest?
2. Which clouds are the lowest?
3. Which clouds are the largest?
4. What are middle-altitude clouds called?
5. What clouds are made of ice crystals? Why are they icy?

Extension Use a cloud reference book or field manual and research the type of weather that is often associated with each cloud type.

Altitude Chart

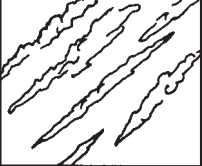
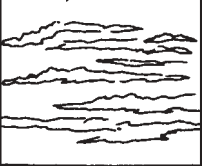

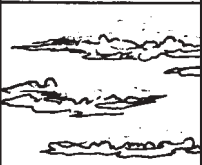
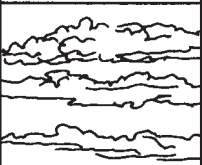
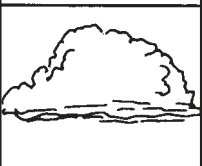
Cloud Chart

Shape	Name	Altitude	Description
	Cirrus	Above 6000 M	Thin, wispy, made of ice crystals On bright night, moon can be seen
	Cirrocumulus	Above 6,000 M	Thin, white puffs of ice crystals Form ripples in high sky
	Cirrostratus	Above 6,000 M	Thin sheet of white ice crystals Make sky look milky
	Alto cumulus	6,000 M - 1,800 M	Small, puffy globules ranging from white to gray in color
	Altostratus	6,000 M - 1,800 M	Thin, layered veil Sun seen as bright spot
	Stratus	1,800 M	Low, uniform, gray layers Usually form drizzle
	Cumulus	1,800 M	Dense, white, and billowy with flat base, single or closely packed
	Cumulonimbus	Very Low	Large, towering, dark gray, usually form thunderstorm or heavy rain
	Nimbostratus	Very Low	Densely layered, dark gray Usually form overcast sky or dense, steady rain

Cyclical Cycles

Purpose

To understand that water can be changed from one state to another by heating and cooling through the process of the water cycle

Procedure

1. Put water into the large bowl until it is about 1cm deep.
2. Add several dashes of salt to the water and stir with the spoon until all the salt grains have completely disappeared. Have a volunteer taste the salty water.
3. Place the small bowl in the center of the large bowl.
4. Cover the large bowl with the plastic wrap. Be sure the plastic wrap clings to the sides of the bowl.
5. Gently set your marble on top of the plastic wrap. Make sure the marble is directly over the small bowl and causes the wrap to sag slightly.
6. Carefully move your bowl to a warm, sunny spot for a few hours. A heat lamp could also be used to reduce experiment time.
7. Remove the plastic wrap and have a volunteer taste the water inside the small bowl.

Conclusion

1. After removing the bowl from the sunlight, describe the changes that have taken place inside the bowl.
2. What caused drops of water to form on the plastic wrap and sides of the bowl?
3. What does the large bowl of saltwater represent in nature?
4. Is the water in the small bowl fresh or salty? Why?
5. Explain how the three-step process of the water cycle is shown in this activity.

Materials

large, clear glass bowl
small glass bowl
pitcher of clean water
salt
stirring spoon
plastic wrap
ruler
small marble

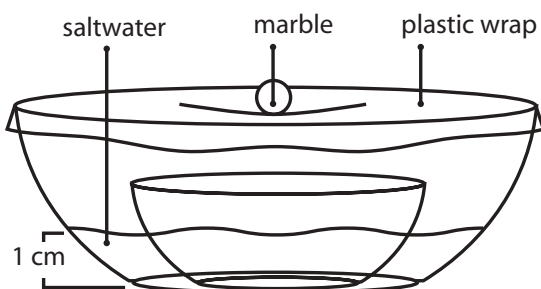

Putting on the Pressure

The atmosphere of Earth is over 600 km thick, and the weight of all that air presses down onto the Earth's surface. The downward force exerted by the weight of air is called its pressure. At the surface of the Earth, the molecules of air are more tightly squeezed together, making the air denser at the bottom of the atmosphere than at higher altitudes. Air density and pressure are greatest at sea level. Air pressure on the surface of the Earth is not always equal due to the heating and cooling of the Earth's surface. Heat makes the molecules of air move and rise and this movement makes the air less dense and thus less heavy. As the warm air rises, the molecules leave the area that is being heated, creating an area of lower air pressure. The reverse is true when the surface of the Earth is cooled.

Air pressure is measured with a barometer. The most common type is an aneroid barometer that measures the expansion and contraction of an airless metal box as the pressure changes. Follow the directions below to make a simple aneroid barometer to use in your class or at home.

Materials

large jar
ruler
large balloon
2 drinking straws
scissors
tape
pen
poster board
clay
science journal

Procedure

1. Use the scissors to cut off the balloon's neck.
2. Stretch the balloon over the mouth of the jar. See diagram 1.
3. Use tape to seal the balloon to the jar and make sure there are no leaks.
4. Tape two straws together end to end.
5. Cut a small triangle out of the poster board and tape it to one end of the straws.
6. Tape the other end of the straws to the top of the balloon. See diagram 2.
7. Make a small ball out of the clay and place the ruler in the middle of the clay so that the ruler is standing perpendicular to the table.
8. Position the jar so that the pointed end of the triangle overlaps the cm edge of the ruler, but make sure it does not touch the ruler. See diagram 3.
9. To measure the air pressure, observe where the pointer is located on the ruler and record in your science journal.
10. Check the position of the pointer at the same time each day and record.



Diagram 1

Conclusion

1. How do the readings vary day to day? Week to week?
2. Is there any difference between sunny and rainy days? Why or why not?

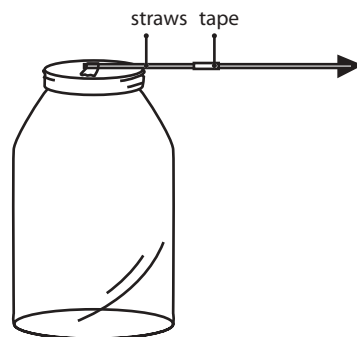

Diagram 2

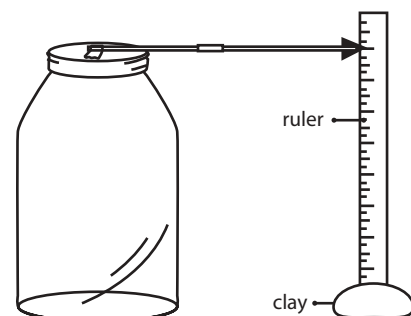

Diagram 3

Convection to Perfection

Purpose

To learn that heat moves in predictable ways, flowing from warmer objects to cooler ones

Procedure

1. Fill the cup with hot water.
2. Add a few drops of food coloring and stir with skewer.
3. Cover the cup with plastic wrap and secure with the rubber band.
4. Place the cup in the center of the jar.
5. Carefully fill the jar with cold water so that the water goes over the cup and nearly to the top of the jar. See diagram.
6. Use the skewer to poke a hole in the plastic wrap and observe.
7. Record your observations in your science journal.

Materials

large jar or aquarium
water
small cup
food coloring
rubber band
plastic wrap
skewer or sharp pencil
science journal

Conclusion

1. Explain what happened and why.
2. How does what happened help explain cloud formation?

Extension

Fill two equally sized jars, one with hot water and one with cold. Add yellow food coloring to the cold water and blue food coloring to the hot. Place a piece of poster board over the open end of one jar. Hold the poster board firmly in place and flip the jar upside down, placing it on top of the other jar. Position the jars so that the lips of each jar are lined up. Slowly and carefully pull the poster board from between the two jars. Observe. Ask other students to guess which jar was hot and which jar was cold.

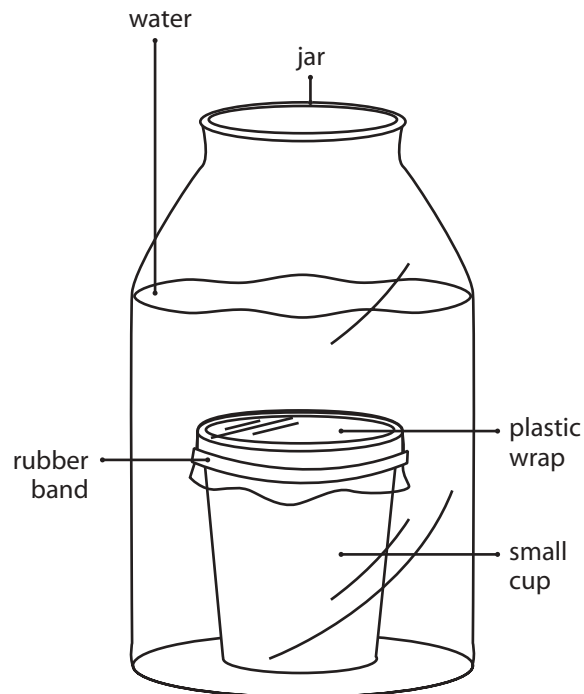

Windy Wind

Purpose To understand how wind is created

Teacher Prep

1. Cut the tops off each bottle.
2. Drill a hole in each bottle approximately 10 cm from the bottom.

Procedure

1. For safety purposes, seal the cut edges of the bottles with tape.
2. From the bottom of each bottle, measure and mark 10 cm, 15 cm, 20 cm, 25 cm, and so on to the top of the bottle. See diagram 1.
3. To connect the bottles, place the ends of the plastic tube in the hole of each bottle. See diagram 2
4. Place clay around the plastic tube and the bottle to seal the opening.
5. Stand the bottles upright and side by side.
6. Fill the pitcher with water, add food coloring, and stir.
7. Fill one bottle with the colored water to the level of the tube.
8. Completely fill the other bottle to the top.
9. Observe what happens and record your observations in your science journal.
10. Experiment with different amounts of water in each bottle.
11. Use a stopwatch or clock with a second hand to determine the amount of time it takes for the various amounts of water to level off.

Materials

- 2 plastic 2-liter bottles
- 30 cm of plastic tubing
- scissors
- food coloring
- tape
- clay
- ruler
- marker
- pitcher of water
- stopwatch (optional)
- ice pick or hand drill

Conclusion

1. What happened to the water levels? Why?
2. How does what happened explain wind?

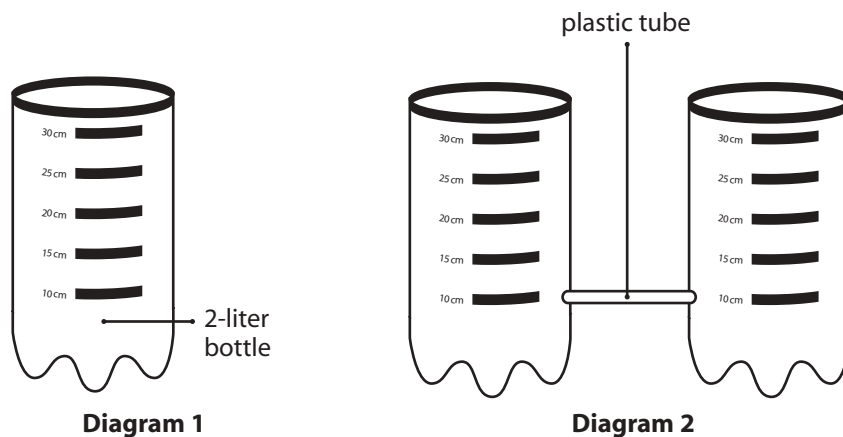

Answer Key

Particular Particles

1. Each salt grain was covered with a droplet of water.
2. Some of the water evaporated and turned into water vapor. This water vapor floated inside the glass until it came in contact with the grains of salt. Once the water vapor touched the cooler salt grains, it condensed and formed a water drop.
3. There are particles floating in the atmosphere. Water vapor condenses around floating particles (such as dust and pollen) and forms tiny droplets around each particle. Millions of these tiny droplets cluster together to form clouds.

It's Time to get Cirrus about Clouds

1. Cirrus clouds are the highest clouds.
2. Stratus clouds are the lowest.
3. Cumulus clouds are the largest.
4. Clouds that begin with the prefix alto. For example, altocumulus or altostratus.
5. Cirrus clouds are made of ice crystals caused by the lower temperatures at higher altitudes.

Cyclical Cycles

1. Water droplets have formed on the plastic wrap and sides of the large bowl. There is some water inside the small bowl.
2. The sunlight heated the water in the bowl, turning it into water vapor. As the water vapor rose, it touched the plastic wrap and the sides of the bowl, causing the water vapor to cool and change back to droplets of water called condensation.
3. The water contained in the oceans.
4. It is fresh water. The sunlight evaporated the water, but the salt does not evaporate and is left behind in the large bowl.
5. Evaporation - the water is being heated by the Sun and turned to water vapor.
Condensation - water vapor is cooling and turning back to water droplets.
Precipitation - water is collecting underneath the marble until it gets heavy enough to fall into the small bowl.

Putting on the Pressure

1. The air pressure readings should vary from day to day and week to week. Variances will differ.
2. There will be a difference between sunny days and rainy days. Sunny days usually have higher pressure and rainy days have lower pressure.

Convection to Perfection

1. When a gas or liquid is warmed, its molecules move apart. The fluid takes up more space, but the number of molecules is the same, so it becomes less dense than its cooler surroundings. Because it is less dense, it rises through the cooler fluid until it reaches a level where the substance above is less dense than it is. The fluid then cools and sinks. When a gas or liquid transfers heat like this, it is called convection.
2. Clouds are formed when air near the Earth's surface is heated and rises just like the hot water. As the hot air rises, the water vapor in the air cools and condenses, forming clouds. As more water vapor rises and cools, the clouds will either become saturated and rain will occur, or the clouds will begin to sink and dissipate.

Windy Wind

1. Even though the hole in the bottle with the least amount of water was covered by water, the water from the full bottle still flowed into it. There was less pressure in the bottle with less water, and the water continued to flow until the pressure difference between the bottles evened out.
2. Air flows from a high-pressure area to a low-pressure area, much like water flows from a higher to a lower level. The greater the differences between pressure areas, the greater the wind speed.



The NASA "Why?" Files
The Case of the
Phenomenal Weather

Segment 2

After learning about the various types of clouds and that weather is very unpredictable, the tree house detectives decide that they had better learn more about hurricanes. They visit Dr. Steve Lyons at the Weather Channel in Atlanta, Georgia, who explains how hurricanes grow and strengthen as they gain water vapor. Once the tree house detectives "survive" a hurricane at the Museum of Science Institute (MOSI) in Tampa, Florida, they are convinced they need to find out how much water vapor the hurricane is receiving. They visit Ed Browell at NASA Langley Research Center, who explains how NASA collects data by using LIDAR to determine water vapor in a hurricane. At the end of this segment, the tree house detectives visit the Hurricane Hunters in Biloxi, Mississippi as they try to chase down more information about hurricanes!

Objectives

The students will

- learn how to plot coordinates on a map.
- understand that energy is a property of many substances, is associated with heat, and is transferred in many ways.
- learn how high- and low-pressure systems are formed on Earth.
- understand how hurricanes are formed.
- understand the Coriolis effect.
- learn how scientists collect data to determine water vapor.
- learn that light interacts with matter by absorption and scattering.
- learn the categories of hurricanes.

Vocabulary

Coriolis effect - the effect of Earth's rotation on the movement of air masses

counterclockwise - in a direction opposite to that in which the hands of a clock rotate

eye wall - the ring of thunderstorms that surrounds a storm's eye. The heaviest rain, strongest winds, and greatest turbulence are normally in the eye wall.

hurricane - large, swirling, low-pressure system with winds of at least 74 mph that forms over tropical oceans. Depending on the location of the storm, it is also called cyclone, typhoon, and willy willie.

hurricane season - The portion of the year having a relatively high incidence of hurricanes. The hurricane season in the Atlantic, Caribbean, and Gulf of Mexico runs from June 1 to November 30. The hurricane season in the Eastern Pacific basin runs from May 15 to November 30. The hurricane season in the Central Pacific basin runs from June 1 to November 30.

latitude - distance measured by degrees north or south from the equator

LIDAR - acronym for Light Detection and Ranging. An instrument that uses pulses of laser light to detect particles or gases in the atmosphere.

longitude - distance measured by degrees or time east or west from the prime meridian

meteorologist - scientist who studies the atmosphere and atmospheric phenomena

prevailing westerlies - winds between 30° and 60° north and south of the equator that blow opposite to the trade winds and cause much of our weather

reconnaissance - a survey of an area to gain information

scattering - bouncing of light in another direction when it hits a molecule in the atmosphere

trade winds - steady winds about 15 degrees north and south of the equator; caused by cool, descending air

tropical storm - a storm with winds between 39 and 74 mph

water vapor - water in a gaseous form, especially when below boiling temperature and spread through the atmosphere

Video Component

Implementation Strategy

The NASA "Why?" Files is designed to enhance and enrich the existing curriculum. Two to three days of class time is suggested for each segment to fully use video, resources, activities, and web site.

Before Viewing

1. Prior to viewing Segment 2 of *The Case of the Phenomenal Weather*, discuss the previous segment to review the problem and what the tree house detectives have learned thus far. Download a copy of the Problem Board from the NASA "Why?" Files web site and have students use it to sort the information learned so far.



2. Review the list of questions and issues that the students created prior to viewing Segment 1 and determine which if any were answered in the video or in the students' own research.
3. Revise and correct any misconceptions that may have been dispelled during Segment 1. Use tools located on the Web, as was previously mentioned in Segment 1.
4. Focus Questions - Print the questions from the web site ahead of time for students to copy into their science journal. Encourage students to take notes during the program to answer the questions. An icon will appear when the answer is near.
5. What's Up? Questions - Questions at the end of the segment help students predict what actions the tree house detectives should take next in the investigation process and how the information learned will affect the case. These can be printed from the web site ahead of time for students to copy into their science journals.

View Segment 2 of the Video

For optimal educational benefit, view *The Case of the Phenomenal Weather* in 15-minute segments and not in its entirety. If you are viewing a taped copy of the program, you may want to stop the video when the Focus Question icon appears to allow students time to answer the question.

Careers

meteorologist
 flight meteorologist
 oceanographers
 storm chasers
 hurricane forecaster

After Viewing

1. Have students reflect on the "What's Up? Questions" asked at the end of the segment.
2. Discuss the Focus Questions.
3. Have students work in small groups or as a class to discuss and list what new information they have learned about weather and tropical storms. Organize the information and determine if any of the students' questions from Segment 1 were answered.
4. Decide what additional information is needed for the tree house detectives to predict if the weather will keep them from going to the physics fair and/or Florida. Have students

conduct independent research or provide students with information as needed. Visit the NASA "Why?" Files web site for an additional list of resources for both students and educators.

5. Choose activities from the educator guide and web site to reinforce concepts discussed in the segment. Pinpoint areas in your curriculum that may need to be reinforced and use activities to aid student understanding in those areas.
6. If time did not permit you to begin the web activity at the conclusion of Segment 1, refer to number 6 under "After Viewing" on page (p. 13) and begin the Problem-Based Learning activity on the NASA "Why?" Files web site. If the web activity had begun, monitor students as they research within their selected roles, review criteria as needed, and encourage the use of the following portions of the online, Problem-Based Learning activity:

Research Rack - books, internet sites, and research tools

Problem-Solving Tools - tools and strategies to help guide the problem-solving process

Dr. D's Lab - interactive activities and simulations

Media Zone - interviews with experts from this segment

Expert's Corner - listing of Ask-An-Expert sites and biographies of experts featured in the broadcast

7. Have students write in their journals what they have learned from this segment and from their own experimentation and research. If needed, give students specific questions to reflect upon as suggested on the PBL Facilitator Prompting Questions instructional tool found in the educator's area of the web site.
8. Continue to assess the students' learning, as appropriate, by using their journal writings, problem logs, scientific investigation logs, and other tools that can be found on the web site. Visit the Research Rack in the tree house, the online PBL investigation main menu section "Problem Solving Tools," and the "Tools" section of the educator's area for more assessment ideas and tools.



Resources

Books

- Allaby, Michael: *Reader's Digest: How the Weather Works*. Dorling Kindersley Ltd., 1995, ISBN: 089577612X.
- Challoner, Jack: *Eyewitness: Hurricane and Tornado*. DK Publishing, 2000, ISBN: 0789452421.
- Cole, Joanna: *The Magic School Bus Inside a Hurricane* (Magic School Bus Series). Scholastic Trade, 1996, ISBN: 0590446878.
- Simon, Seymour: *Storms*. Mulberry Books, 1992, ISBN: 0688117082.
- Williams, Jack: *USA Today: The Weather Book*. Vintage Books, 1997, ISBN: 0679776656.

Web Sites

- National Hurricane Center**
Visit this site for the latest in satellite images, hurricane tracking charts, hurricane preparedness information, and much more.
<http://www.nhc.noaa.gov/>
- The Hurricane Hunters**
Come and read about the men and women who fly into the center of hurricanes! There are photos, movies, history, fact files, and much more. You can even e-mail your question to a hurricane hunter.
<http://www.hurricanehunters.com/>
- LIDAR**
At this web site learn more about the wonderful world of LIDAR.
<http://asd-www.larc.nasa.gov/lidar/lidar.html>

Activities and Worksheets

In the Guide	Plotting to Rescue Help rescue the survivors as you learn how to plot coordinates.	29
	What About Air? Try a few of these experiments to learn more about air.	32
	Things are Heating Up! Learn how heat makes air expand and rise.	33
	Vaporizing Vapor Try this activity to better understand water vapor in the atmosphere.	34
	Humble Humidity Use this activity to find the relative humidity.	35
	Answer Key	37
On the Web	Catchin' a Breeze Experiment to learn how wind is created.	
	Round and Round We Go An activity to help students understand the Coriolis effect.	



Plotting to Rescue

Purpose

To use lines of latitude and longitude to locate a position on a coordinate graph

Procedure

1. Label one envelope "longitude" and one envelope "latitude."
2. Using scissors, cut along dotted lines to separate the game cards.
3. Place the longitude cards (N and S) in the longitude envelope and the latitude cards (E and W) in the latitude envelope.
4. Lay the game board on a flat surface and place a chip (survivor) on an island. Repeat until all survivors have been distributed.
5. Read the following scenario to your partner.

A fishing boat caught in a tropical storm sank after battling the storm for several hours. Fortunately, all of the crewmembers were able to swim to nearby deserted islands. Each survivor has a device that transmits his or her longitude and latitude coordinates. As a member of the Marine Rescue Team, use the coordinates to locate and rescue as many survivors as you can!

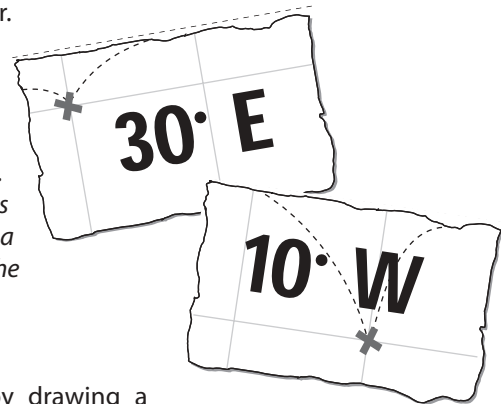

6. The youngest player starts the game by drawing a latitude and a longitude card from each envelope.
7. Using the coordinates, find where the longitude and latitude lines meet. If the lines meet on an island where there is a survivor, rescue the survivor.
8. Return the cards to their envelopes.
9. Play will continue with the next person on the left and so on until all the survivors have been rescued. The player with the most survivors wins the game.

Materials

game card sheet (p. 30)
 game board (p. 31)
 15 plastic chips or beans
 2 envelopes
 scissors
 highlighter (optional)
 pencil

Plotting to Rescue - Game Card Sheet

Longitude Cards

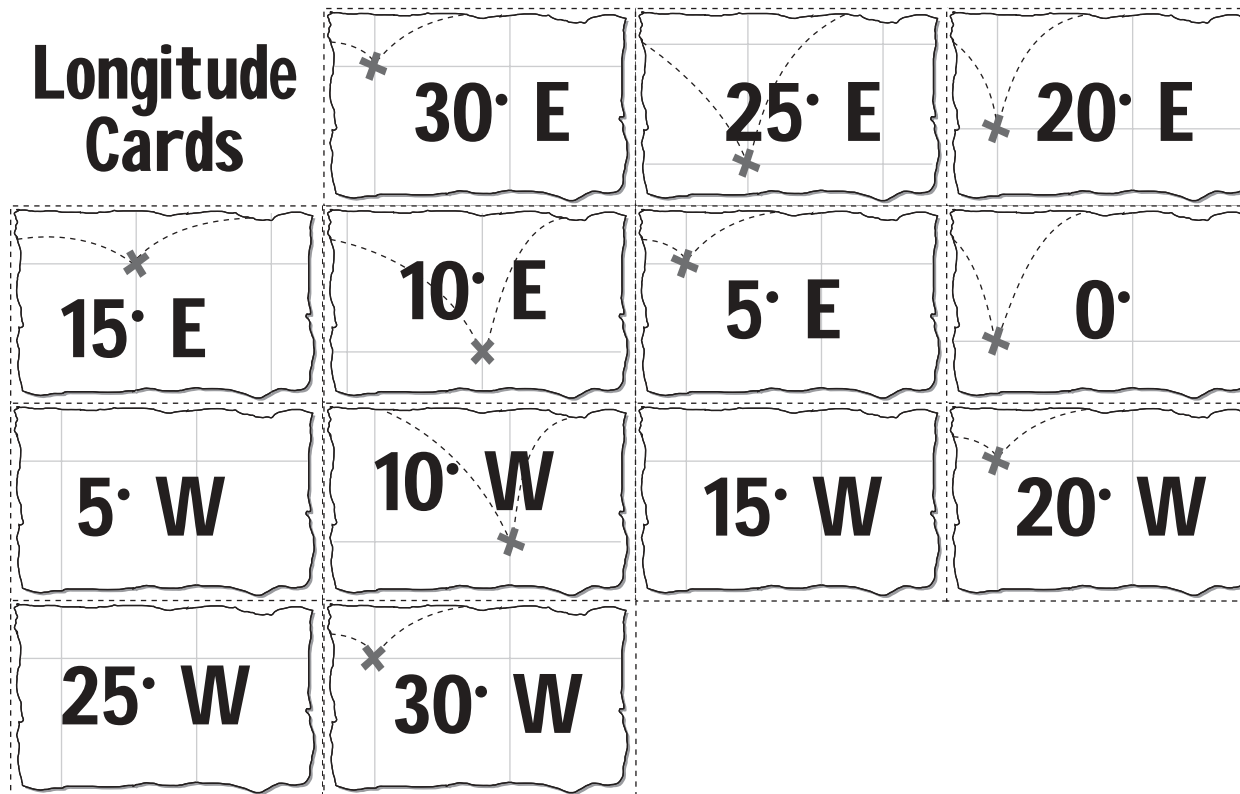

Latitude Cards

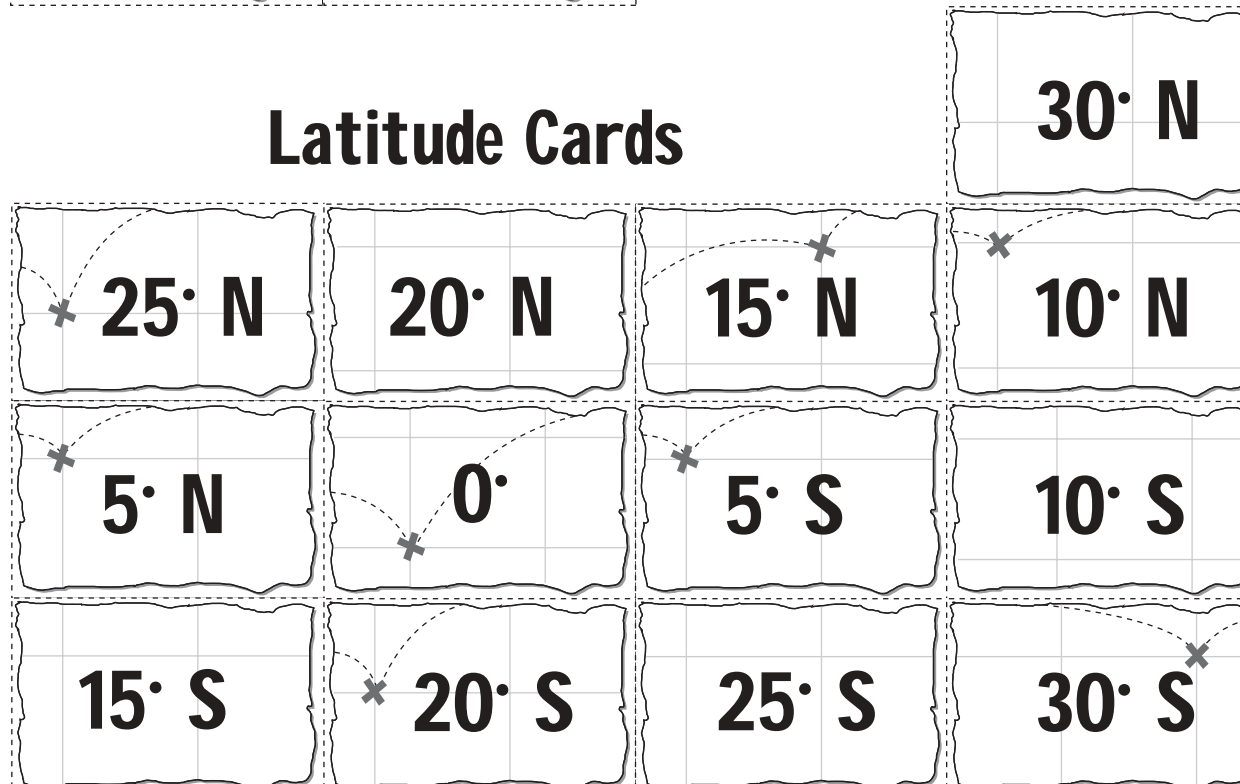

Plotting to Rescue - Game Board

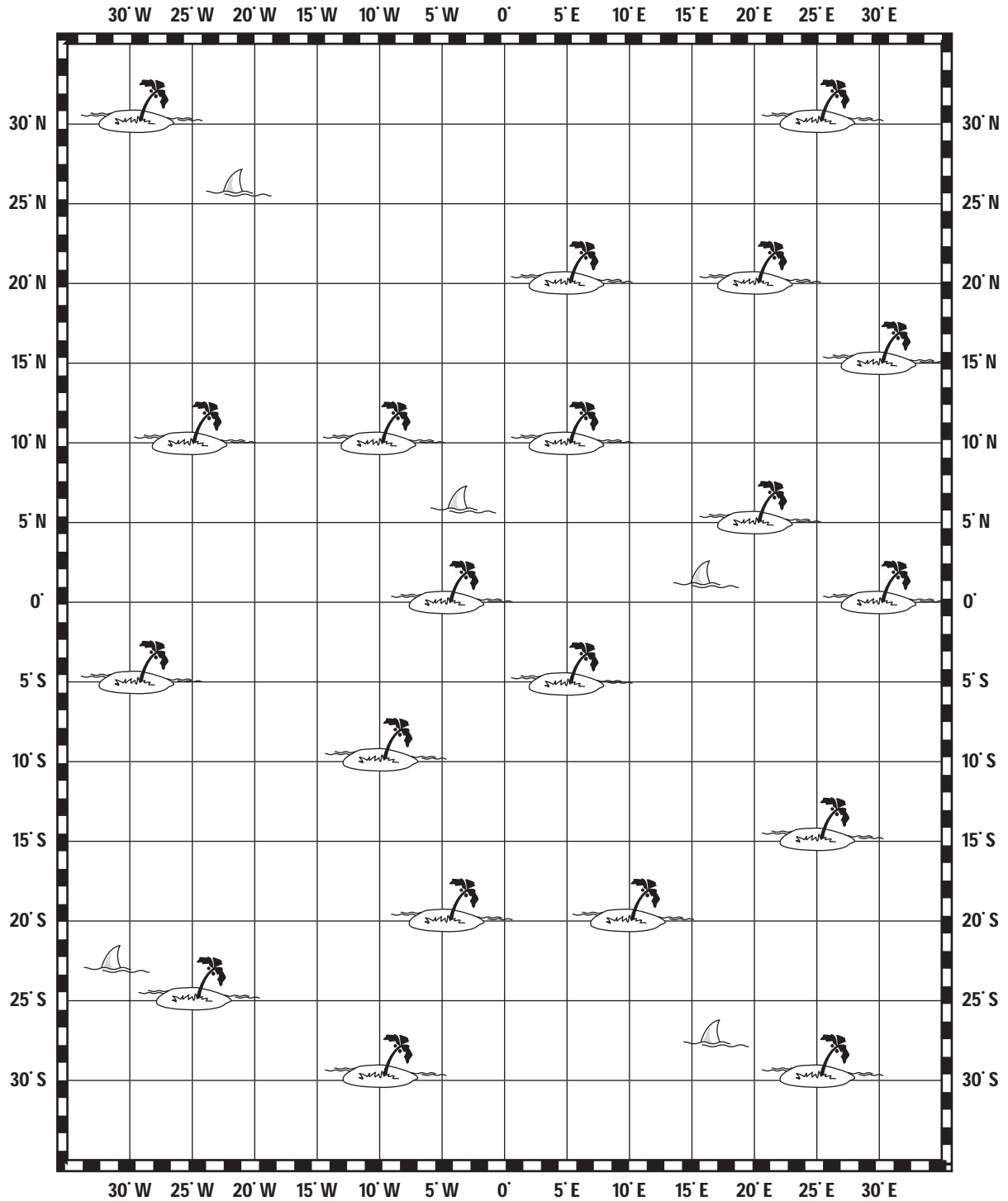

What About Air?

Although you cannot see it, air is all around you. Try a few of these simple experiments to learn some characteristics of air. The more you know about air, the easier it is to learn about weather.

Where's the Air?

Fill a large tub or sink with water and push an empty plastic bottle into the water. Let the bottle fill with water and watch what happens to the water. Was the bottle really empty?

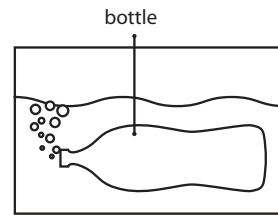

Where's the Air?

Some Pushy Air

Tear a sheet of newspaper in half and smooth it out on a flat surface such as a table. Put a ruler under the paper so it sticks out over the edge of the table. Stand to one side and press down on the ruler to see if you can snap it off the table. Was there an unseen force holding the paper and ruler to the table?

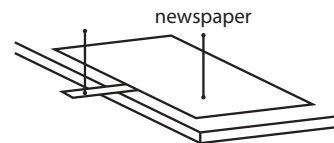

Some Pushy Air

Magic Air

Fill a plastic glass or cup with water to the brim. Put a piece of cardboard on top of the cup and turn the cup upside down, holding the cardboard in place. Make sure there are no gaps between the cup and the cardboard. Let go of the cardboard and see what happens. What was the magic in this trick?

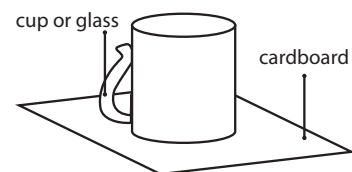

Magic Air

Shrinking Air

Fill a 2-liter soda bottle about one-third full of crushed ice. Replace the cap on the bottle and shake it for about a minute. Observe the bottle as the ice cools the air inside. What happened to the air inside the bottle?

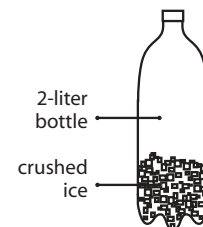

Shrinking Air

Rising Air

On a piece of construction paper, trace the outline of a plate to form a large circle. Cut out the circle. Starting at one edge of the circle, begin to draw around and around inside the circle to make a spiral. Color the spiral and cut it out. Place a string on the top end of the spiral and let it hang. Place the spiral over a lamp and observe. What causes the spiral to move?

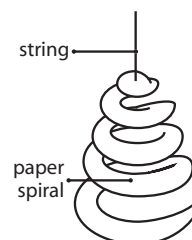

Rising on Air

Flying on Air

Take two identical sheets of paper and crumple one of the sheets into a ball. Hold both sheets at the same height and drop them at the same time. Which one landed first and why?

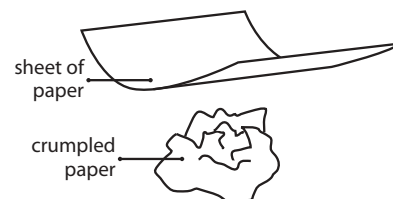

Flying on Air



Things Are Heating Up!

High- and low-pressure systems all start with the Sun. Heat causes air to expand and become less dense. The air then rises, leaving an area of low pressure. Because the cooler air higher in the atmosphere is denser, it sinks and replaces the air that has risen, creating an area of high pressure. When this new air sinks toward Earth, it is warmed and the cycle continues. The replacement of the warmed (less dense) air by cooler (more dense) air is called a convection current.

Materials

small latex balloon
rubber bands
large salad dressing bottle
hot water
large rectangular pan,
about 33 x 23 cm
science journal

Purpose

To understand that heat makes air expand and rise
To learn how pressure systems are formed

Procedure

1. Attach the mouth of the balloon to the top of the bottle.
2. Place rubber bands over the balloon onto the neck of the bottle to ensure a tight fit.
3. Pour the hot water into the pan to about 2.5 cm from the top.
4. CAREFULLY place the bottle in the hot water. It may be necessary to hold the bottle down.
5. Observe and record your observations.
6. Carefully place the bottle and balloon in a refrigerator or a tub of ice for 10-15 minutes.
7. Observe and record your observations.

Conclusion

1. What happens to the air in the bottle?
2. Explain how you know that is what happened.
3. How did what happened demonstrate convection?
4. How are low-pressure systems formed?
5. Explain the formation of a high-pressure system.

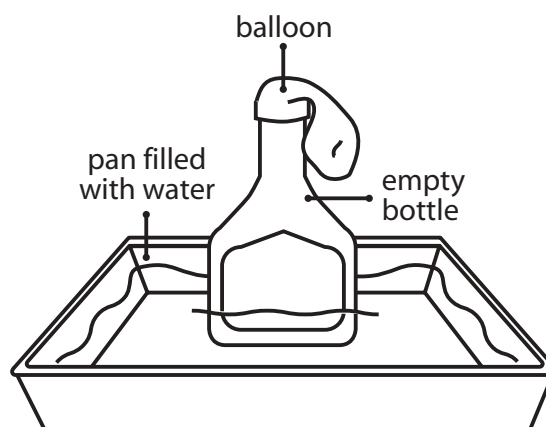

Vaporizing Vapor

Problem To understand water vapor in the atmosphere

Procedure

1. Fill the large pan with water.
2. Put the sponge into the pan.
3. Observe the sponge and record.
4. Lift the sponge out of the pan. Observe and record.

Materials

large pan
water
sponge
science journal

Conclusion

1. What happened to the sponge when you put it in the pan?
2. When you lifted the sponge, why did it leak?

Background The sponge soaks up the water, but not all of it. The sponge soaks up as much water as it can hold. Eventually, the sponge is "full" and cannot soak up any more. We say that the sponge is saturated. Air is like a sponge. It can also hold water and water in air is in the form of gas. Water in gas form is called water vapor. The amount of water vapor in the air does not stay the same. Sometimes air has a small amount of water vapor and sometimes it has a lot. When the air becomes saturated like the sponge, there is precipitation. The amount of water vapor air can hold depends on the temperature. Warm air holds more water vapor than cold air. Relative humidity tells us how "full" the air is with water vapor. It compares the amount of water vapor in the air to how much the air can hold.

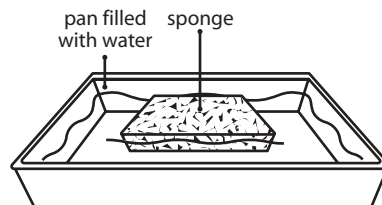

Look at the cubes of air below and answer the following questions:
The temperature in each cube is 24° C; the balls stand for water vapor.

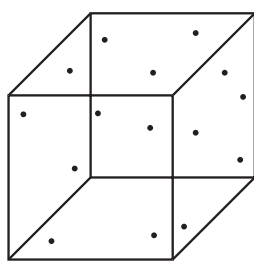

A

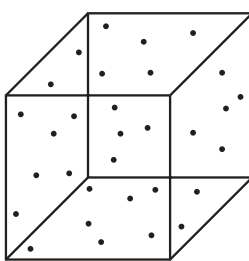

B

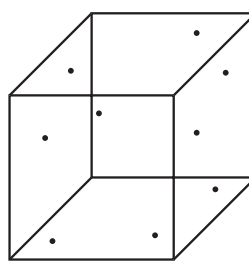

C

3. Which air has the least water vapor? _____
4. Which air has the most water vapor? _____
5. Which air is the dampest? _____
6. Which air is the driest? _____
7. Which air has the highest relative humidity? _____
8. Which air has the lowest relative humidity? _____
9. Which air might have rain soon? _____



Humble Humidity

Purpose To find the relative humidity with a psychrometer

- Procedure**
1. Use a string to attach a small piece of cloth to the bulb of one of the thermometers. See diagram 1.
 2. Cut two pieces of string approximately 30 cm long.
 3. Attach the string through the hole and tie in a knot. Repeat for the second thermometer. If the thermometers do not have holes, the teacher can make a hole with a nail and a hammer or you can use tape to attach the strings securely to the back of the thermometer. See diagram 2.
 4. Wet the cloth on the bulb. This one will be the wet bulb thermometer and the other will be the dry bulb.
 5. You and your partner each take a thermometer and hold the string carefully looped around your hand. Slowly twirl the two thermometers for two minutes. Be sure to stand several meters apart from each other so that the thermometers do not collide as you are swinging them.
 6. Stop twirling and read and record the temperature of both thermometers.
 7. Subtract the wet bulb temperature reading from the dry bulb temperature.
 8. To find the humidity in the room, use the relative humidity chart on p. 36 and follow these steps:
 - a. Locate the dry bulb temperature along the left edge of the chart.
 - b. Locate the difference between the dry bulb and wet bulb temperature along the top edge of the chart.
 - c. Use your fingers to follow each to the place they intersect.
 9. This intersection shows the relative humidity. It is usually expressed as a percent. Record in your journal.
 10. Repeat in various other rooms and outside.

- Conclusion**
1. Explain relative humidity.
 2. Eventually, what will happen if an area continues to receive large amounts of water vapor?
 3. In a hurricane, where does the storm get its water vapor?
- Bonus:** Why is warm water necessary for hurricanes to form?

Materials

- 2 metal thermometers
- small piece of cloth
- string
- water
- humidity chart
- science journal
- clock with second hand or egg timer

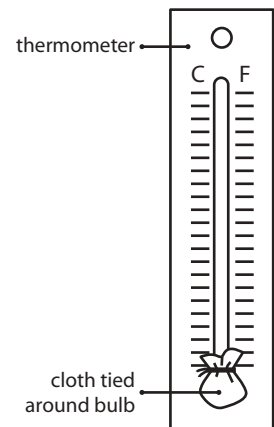

Diagram 1

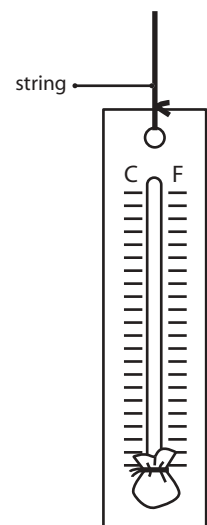

Diagram 2

Humble Humidity

Relative Humidity Chart

Dry Bulb Temp	Dry Bulb Temperature Minus Wet Bulb Temperature (C°)									
	1	2	3	4	5	6	7	8	9	10
10° C	88	77	66	55	44	34	24	15	6	
11° C	89	78	67	56	46	36	27	18	9	
12° C	89	78	68	58	48	39	29	21	12	
13° C	89	79	69	59	50	41	32	22	15	7
14° C	90	79	70	60	51	42	34	26	18	10
15° C	90	80	71	61	53	44	36	27	20	13
16° C	90	81	71	63	54	46	38	30	23	15
17° C	90	81	72	64	55	47	40	32	25	18
18° C	91	82	73	65	57	49	41	34	27	20
19° C	91	82	74	65	58	50	43	36	29	22
20° C	91	83	74	67	59	53	46	39	32	26
21° C	91	83	75	67	60	53	46	39	32	26
22° C	92	83	76	68	61	54	47	40	34	28
23° C	92	84	76	69	62	55	48	42	36	30
24° C	92	84	77	69	62	56	49	43	37	31
25° C	92	84	77	70	63	57	50	44	39	33
26° C	92	85	78	71	64	58	51	46	40	34
27° C	92	85	78	71	65	58	52	47	41	36
28° C	93	85	78	72	65	59	53	48	42	37
29° C	93	86	79	72	66	60	54	49	43	38
30° C	93	86	79	73	67	61	55	50	44	39



Answer Key

What About Air?

Where's the Air? The bottle was not empty, it was full of air. When you pushed the bottle under the water to fill it up, the air escaped in the form of bubbles. Most things that look empty are really full of air!

Some Pushy Air The air all around you was pushing down on the newspaper and keeping it in place. The newspaper has a large surface area and that is a lot of weight pressing down!

Magic Air There was no magic, just air. The air pressing around us, pushed up on the cardboard to keep it in place, making the water stay in the cup unless the seal is broken!

Shrinking Air Due to the ice in the bottle, the air inside the bottle cooled. As it cooled, the molecules slowed down and came nearer to each other, making the air denser than before. Since dense air does not take up as much space, the air pressing on the outside of the bottle pressed inward, causing the bottle's sides to go inward.

Rising Air The lightbulb heats the air surrounding it. Because air molecules spread out when heated, a certain volume of hot air is lighter (less dense) than the same volume of cold air, making the hot air rise and float above the cold air. As the air rises, it causes the spiral to move.

Flying on Air The paper that was crumbled into a ball hit the floor first. Air pushes up on the paper pieces as they drop. The flat piece of paper is larger so more air can push against it, thus making it fall more slowly than the smaller ball. When things move through the air, they have to overcome the air pressure rushing against them. This slowing-down effect of the air is called air resistance. Some shapes have more air resistance than others.

Things are Heating Up!

1. The air in the bottle expanded as it was heated by the hot water. As the molecules got hot, they moved farther away from each other.
2. You know because the balloon began to inflate and became larger.
3. In convection, the air is heated at the surface of the Earth, which causes the molecules to move away from each other, creating less dense air. Now that the air is less dense, it will begin to rise. As the air rises, it begins to cool. As it cools, the molecules move closer together and the air becomes denser. The air will begin to fall again back toward the Earth. The cycle of convection was demonstrated when the balloon increased in size as the air warmed and then became smaller as the air

cooled.

4. Low-pressure systems are created when the air near the surface of the Earth is heated. When air warms, the air molecules spread out so there are fewer air molecules in the same space. Warm air weighs less than cool air, which means that warm air presses down on Earth less than cool air does. A mass of warming air is an area of low pressure.
5. When air cools, the air molecules come closer together, so there are more air molecules in the same space. The air mass becomes heavier and sinks toward the Earth, creating an area of high pressure.

Vaporizing Vapor

1. The sponge absorbed the water.
2. The sponge was full of water and could not hold any more.
3. C 4. B 5. B 6. C 7. B 8. C 9. B

Humble Humidity

1. Relative humidity is the amount of water vapor that air can hold at a certain temperature.
2. Eventually, the air will become saturated, and it will have some form of precipitation (rain, sleet, snow, or hail).
3. The hurricane gets its water vapor from the warm ocean water.

Bonus: Warm water is necessary for a hurricane to form because the warm water heats the air above its surface, and the warm air rises, creating clouds. As the warm ocean water continues to feed water vapor into the air, the clouds become larger and more saturated. Finally, the clouds will become a storm, and as it continues to receive water vapor, the storm will grow stronger and stronger.

The NASA "Why?" Files
The Case of the
Phenomenal Weather

Segment 3

Hurricane Ichabod has now reached Category II status, and the tree house detectives wonder what it would be like to live through a hurricane. They contact the Juarez family in Miami, Florida, who went through Hurricane Andrew in 1992 and discover that it is not something they want to experience firsthand. The tree house detectives are now more determined than ever to learn where Hurricane Ichabod will make landfall! They visit Dr. D's to learn more about probability and prediction. Dr. D directs them to NASA Langley Research Center and Anita Rapp to learn how satellites track and collect data on hurricanes and other weather phenomenon. Ms. Rapp tells the tree house detectives that they need to visit Dr. Bill Smith to learn about GIFTS, a satellite of the future that will save many lives and millions of dollars in property damage by offering earlier warnings and more accurate predictions of landfall.

Objectives

The students will

- learn how hurricane paths are predicted.
- learn about probability.
- learn how to determine the volume of an irregular shaped object.
- learn that global patterns of atmospheric movement influence local weather.
- learn that gravity is the force that keeps satellites in orbit around Earth.
- understand how satellites orbit the Earth to collect data.
- learn that natural hazards can present personal and societal challenges because incorrectly estimating the rate and scale of change may result in either too little attention and significant human costs or too much cost for unneeded preventive measures.

Vocabulary

geostationary - a type of satellite that only sees the same portion, a fixed point, of the Earth at all times

GIFTS - an acronym for Geostationary Imaging Fourier Transform Spectrometer

gravity - an attractive force that exists between all objects

momentum - the characteristic of a moving body that is caused by its mass and its motion

polar orbiting - a type of satellite that covers the entire surface of the Earth

predict - to declare in advance, foretell on the basis of observation, experience, or reasoning

probability - a measure of how often a particular event will happen if something such as tossing a coin is done repeatedly and results in any of a number of possible outcomes

satellite - a heavenly body or man-made object orbiting another of larger size

tornado - a violent, destructive whirling wind accompanied by a funnel-shaped cloud that moves in a narrow path over the land

Video Component

Implementation Strategy

The NASA "Why?" Files is designed to enhance and enrich the existing curriculum. Two to three days of class time is suggested for each segment to fully use video, resources, activities, and web site.

Before Viewing

1. Prior to viewing Segment 3 of *The Case of the Phenomenal Weather*, discuss the previous segment to review the problem and what the tree house detectives have learned thus far. Download a copy of the Problem Board from the NASA "Why?" Files web site and have students use it to sort the information learned so far.
2. Review the list of questions and issues that the students created prior to viewing Segment 2 and determine which, if any, were answered in the video or in the students' own research.
3. Revise and correct any misconceptions that may have been dispelled during Segment 2. Use tools located on the web, as was previously mentioned in Segment 1.
4. Focus Questions—Print the questions from the web site ahead of time for students to copy into their science journals. Encourage students to take notes during the show to answer the questions. An icon will appear when the answer is near.
5. What's Up? Questions—Questions at the end of the segment help students predict what actions the tree house detectives should take next in the investigation process and how the information learned will affect the case. These questions can be printed from the web site ahead of time for students to copy into their science journal.

View Segment 3 of the Video

For optimal educational benefit, view *The Case of the*



Careers

weather observer
tornado observer
tornado chaser
climatologist

Phenomenal Weather in 15-minute segments and not in its entirety. If you are viewing a taped copy of the program, you may want to stop the video when the Focus Question icon appears to allow students time to answer the question.

After Viewing

1. Have students reflect on the "What's Up?" questions asked at the end of the segment.
2. Discuss the Focus Questions.
3. Have students work in small groups or as a class to discuss and list what new information they have learned about weather and tropical storms. Organize the information, place it on the Problem Board, and determine whether any of the students' questions from Segment 2 were answered.
4. Decide what additional information is needed so the tree house detectives can predict if the weather will keep them from going to the physics fair and/or Florida. Have students conduct independent research or provide students with information as needed. Visit the NASA "Why?" Files web site for an additional list of resources for both students and educators.
5. Choose activities from the educator guide and web site to reinforce concepts discussed in the segment. Pinpoint areas in your curriculum that may need to be reinforced and use activities to aid student understanding in those areas.
6. If time did not permit you to begin the web activity at the conclusion of Segments 1 or 2,

refer to number 6 under "After Viewing" (p. 13) and begin the Problem-Based Learning activity on the NASA "Why?" Files web site. If the web activity had begun, monitor students as they research within their selected roles, review criteria as needed, and encourage the use of the following portions of the online, Problem-Based Learning activity:

Research Rack - books, internet sites, and research tools

Problem-Solving Tools - tools and strategies to help guide the problem-solving process.

Dr. D's Lab - interactive activities and simulations

Media Zone - interviews with experts from this segment

Expert's Corner - listing of Ask-An-Expert sites and biographies of experts featured in the broadcast

6. Have students write in their journals what they have learned from this segment and from their own experimentation and research. If needed, give students specific questions to reflect upon, as suggested on the PBL Facilitator Prompting Questions instructional tool found in the educator's area of the web site.
7. Continue to assess the students' learning, as appropriate, by using their journal writings, problem logs, scientific investigation logs, and other tools that can be found on the web site. Visit the Research Rack in the tree house, the online PBL investigation main menu section "Problem Solving Tools," and the "Tools" section of the Educator's area for more assessment ideas and tools.

Resources

Books

Brandley, Franklyn M.: *Tornado Alert*. Harper Trophy, 1990, ISBN: 0064450945.

Hood, Susan: *The Weather Channel: Hurricanes!* Simon Spotlight, 1998, ISBN: 0689820178.

Petty, Kate: *I didn't know that people chase twisters and other amazing facts about violent weather*. Copper Beech Books, 1998, ISBN: 076130715X.

Rose, Sally: *The Weather Channel: Tornadoes!* Simon Spotlight, 1999, ISBN: 0689820224.

VanCleave, Janice: *Gravity*. John Wiley and Sons, Inc., 1993, ISBN: 0471550507.

Wallner, Alexandra: *Sergio and the Hurricane*. Henry Holt & Company, 2000, ISBN: 0805062033.



Web Sites

FEMA for Kids

This web site is filled with games, student artwork, activities, and cutting-edge graphics that deliver a serious message of disaster preparedness and mitigation for youngsters preschool through eighth grade.

<http://www.fema.gov/kids/>

Red Cross Hurricane Safety Site

Explore this web site to learn what a "watch" and a "warning" mean, prepare a personal evacuation plan, learn what to do before, during, and after a hurricane, and much more.

<http://www.redcross.org/services/disaster/keepsafe/readyhurricane.html>

Weather Channel Hurricane Safety

Great site to learn all about hurricanes and how to prepare for an approaching storm.

<http://www.weather.com/safeside/tropical/>

GIFTS

Visit this web site to learn more about the future of the GIFTS satellite.

<http://danspc.larc.nasa.gov/GIFTS/sci.html>

NASA Langley Research Center's Atmospheric Sciences

Explore this web site to learn more about various current and future satellites and projects being developed by NASA Langley Research Center.

<http://asd-www.larc.nasa.gov/ASDhomepage.html>

Activities and Worksheets

In the Guide

The Probability Factor

An activity to better understand that probability is a way of measuring the chance that something will happen.43

Around and Around It Goes. Where It Will Stop? Do We Know?

An activity to learn how predictions are made.44

Going Down Anyone?

An activity to observe the force of gravity.45

3-2-1 Blast Off!

Learn how satellites are placed in orbit.46

The Fear Factor

Play a game to learn how natural hazards can have significant costs.47

Answer Key

.....50

On the Web

Turn Up the Volume

Use this activity to determine the volume of irregularly shaped objects

Surging Storm

Understand the effect of storm surge during a hurricane



The Probability Factor

Purpose

To understand that probability is a way of measuring the chance of something happening

Procedure

1. To make a probability tester, glue two golf tees opposite each other on a die.
2. Draw the symbol for a hurricane on one of the dot stickers.
3. Repeat with each of the other dot stickers for a tornado, the Sun, and a cloud.
4. Place the dot stickers on the remaining die faces.
5. Predict how many times each face will land on top for the first trial and record in the data chart below.
6. Spin the probability tester and observe which face of the die is on top.
7. Record in the data chart below.
8. Repeat for 9 more spins.
9. Repeat steps 5-7 for 50 spins.
10. Repeat steps 5-7 for 100 spins.
11. Create a class chart combining the data from all groups.
12. Discuss the results.

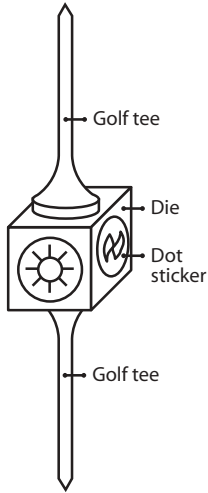

Materials

- 2 golf tees
- die
- 4 dot stickers
- pencil
- glue (super glue works best)

Data Chart

Trials	Hurricane	Tornado	Sun	Cloud
10 spins	Prediction:	Prediction:	Prediction:	Prediction:
	Actual:	Actual:	Actual:	Actual:
50 spins	Prediction:	Prediction:	Prediction:	Prediction:
	Actual:	Actual:	Actual:	Actual:
100 spins	Prediction:	Prediction:	Prediction:	Prediction:
	Actual:	Actual:	Actual:	Actual:

Conclusion

1. How many faces does the probability tester have?
2. What is the chance of any one face landing upright? Explain.
3. When a class chart was created, did a pattern begin to show?
4. In predicting the probability of landfall for a hurricane, a meteorologist uses many tools to try to get the most accurate prediction he/she can. Research how meteorologists predict landfall and write a short paper describing the process.

Extensions

Cyclone Game

1. Play the Cyclone Game in groups of 2-4.
2. Give each student 15 tokens or beans.
3. Each player puts one token in the center.
4. The youngest player will begin by spinning the probability tester.
5. Observe which symbol is facing up and follow these rules:
 - Cloud—takes no tokens
 - Hurricane—takes all tokens
 - Tornado—takes half of the tokens
 - Sun—puts in two tokens
6. Continue playing with the player on the left.
7. When one person has won all tokens, the game is over.

Around and Around It Goes. Where Will It Stop? Do We Know?

Problem To understand how to make a prediction

- Procedure**
1. Sit opposite your partner with a large, flat surface between you.
 2. Predict how the ball will travel when rolled to your partner. Will it travel in a straight line or will it curve? If so, which way will it curve?
 3. Roll the ball and observe.
 4. Record your observation by drawing the path your ball took.
 5. Now, carefully observe the flat surface and the surface of the ball. Discuss any feature that might have affected the ball as it rolled across the surface— dirt, scratches, smoothness, and so on.
 6. Predict the path of the ball and roll it to your partner again.
 7. Observe and record.
 8. Repeat steps 2-7, having your partner roll the ball to you.

Materials

flat surface (floor or table)
small ball or marble
science journal
pencil

- Conclusion**
1. Did the ball always roll in the same path? Explain why or why not? _____

 2. How did observing the flat surface and the ball help you predict the ball's path? _____

 3. Did your partner's ball roll the same way as your's? Why or why not? _____

 4. When predicting the path of a hurricane, what factors would a meteorologist consider? _____



Going Down Anyone?

Problem To observe the force of gravity

- Procedure**
1. Tie the paper clip to one end of the string.
 2. Tie the other end of the string to the center of the ruler.
 3. Stand the two books on a flat surface approximately 25 cm apart.
 4. Lay the ruler across the tops of the books as shown in the diagram.
 5. Observe the position of the string and paper clip.
 6. Record in your science journal by drawing what you see.
 7. Lift one end of the ruler about 10 cm above the top of the book.
 8. Observe and record.
 9. Discuss the results.

Materials

- ruler
- 30-cm string
- 2 books of equal size
- paper clip
- science journal
- pencil

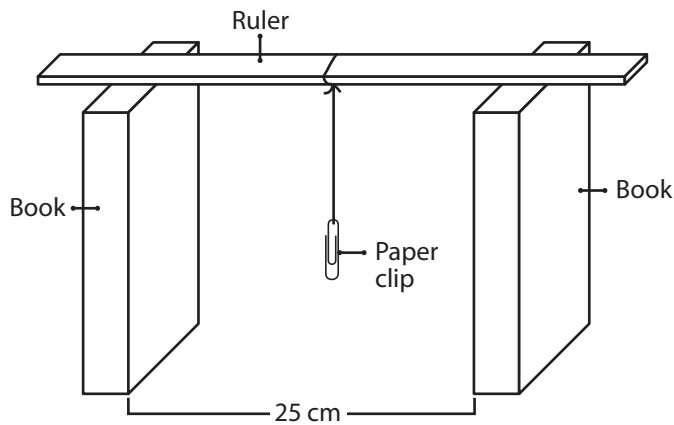

- Conclusion**
1. Did the position of the string change when you lifted the ruler? _____
 2. Explain what happened. _____

3, 2, 1...Blast Off!

Problem

To understand how satellites are placed in orbit

Procedure

1. Position the book about 25 cm from the edge of the table, which represents the Earth.
2. Place one ruler on top of the book with 10 cm of the ruler extending over the edge of the book.
3. Place the second ruler so that one end touches the end of the other ruler with the grooves of the rulers lined up.
4. Raise the other end of the ruler about 5 cm above the book and hold it in that position by placing a clay ball underneath the ruler.
5. Place the marble, which represents a satellite, at the top of the raised ruler and let go.
6. Observe the path of the marble.
7. Launch your satellite several more times.
8. In your science journal, draw and describe your observations.

Materials

large book or cardboard box
2 plastic rulers with center groove
marble
clay
flat table surface
science journal
pencil

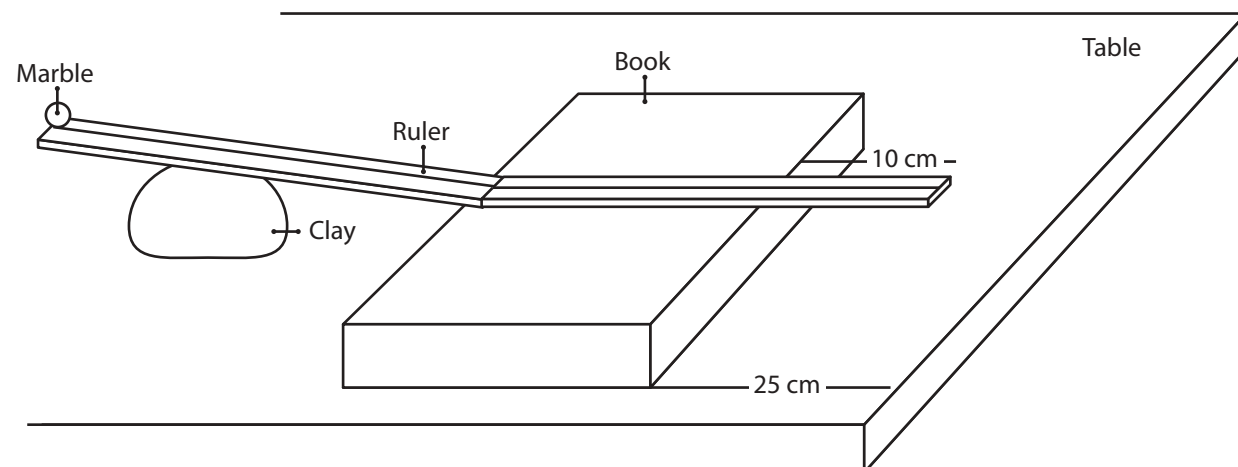

Conclusion

1. Was the path of the marble a straight line or a curved line? _____
2. Explain why the marble did not fall straight down to the floor. _____

3. What force is pulling the marble down toward the floor? _____
4. When a satellite is launched into space, how does it overcome this force? _____

5. What keeps a satellite from falling back to Earth? _____



The Fear Factor

Purpose

The students will learn that natural hazards present personal and societal challenges because misidentifying the change or incorrectly estimating the rate and scale of change may result in either too little attention and significant human costs or too much cost for unneeded preventive measures.

Teacher Prep

To make the spinners:

1. Cut out the circles and place them on top of the cardboard.
2. Trace around each circle and cut out the cardboard.
3. Glue each spinner to a cardboard circle.
4. Using the tip of the scissors, punch a hole in the center of the circle.
5. Cut out the arrows and punch a hole in the end as indicated.
6. Using a brad, connect the arrow to the spinner.
7. Cut out the hurricane disk.

Teacher Note To make playing the game easier, place the game board on a piece of cardboard and use a pushpin to hold the hurricane disk in place.

Materials

spinners (p. 48)
 game board (p. 49)
 cardboard
 scissors
 glue
 2 brads
 die
 play money (p. 48)
 hurricane disk (p. 48)
 game pieces (p. 48)
 pushpin

Procedure

2-4 players

1. Determine who will be the following: banker, meteorologist, and Hurricane Hunter.
2. Roll the die to determine which house is your designated house. If you roll a number that has already been taken, continue to roll until you get one that has not yet been taken.
3. The banker will give each player \$500 to start the game.
4. Place the hurricane disk at the start point on the game board. The hurricane begins as a category 1 hurricane.
5. The meteorologist spins the direction spinner to determine the direction that the storm will move and moves the disk one square in the indicated direction. For NE, SE, SW, and NW, move diagonally. Each spin represents one day.
6. The Hurricane Hunter will spin the category spinner to determine the category of the storm.
7. Each player will decide what to do about his or her house according to the movement and intensity of the storm. Follow the guidelines below:
 - Stay and do nothing:** receive \$100 in pay for another day worked.
 - Prepare and stay:** pay \$200 for the day lost at work and the cost of preparing your home.
 - Prepare and evacuate:** pay \$100 for preparing your home plus a \$100 each day you are evacuated.
 - Evacuate:** pay \$200 for each day you are evacuated.
8. Continue to play the game until the hurricane makes landfall. Follow the guidelines below:
 - If you are within two squares of landfall:**
 - If you stayed and did nothing: pay \$500
 - If you prepared and stayed: pay \$200
 - If you prepared and evacuated: pay nothing
 - If you evacuated but did not prepare: pay \$300
 - If you are within three squares of landfall:**
 - If you stayed and did nothing: pay \$300
 - If you prepared and stayed: pay \$100
 - If you prepared and evacuated: pay nothing
 - If you evacuated but did not prepare: pay \$200
 - If you are within 4-6 squares of landfall: pay \$200
 - If you are within 7 or more squares of landfall or if the storm decreases below a category 1 hurricane, there are no charges.**
9. The player with the most money at the end of the game wins.

The Fear Factor

Conclusion

1. What factors influenced your decisions about preparing for the hurricane?
2. Can you ever accurately predict what a hurricane will do? Why or why not?
3. For every mile of coastline evacuated, the price paid is approximately \$1 million. Knowing the cost to evacuate, would you be more cautious in issuing watches and warnings if you were the meteorologist? Why or why not?
4. What is the probability for the storm to move North?
5. What is the probability for the storm to increase in strength?

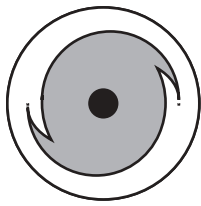

Hurricane Disk

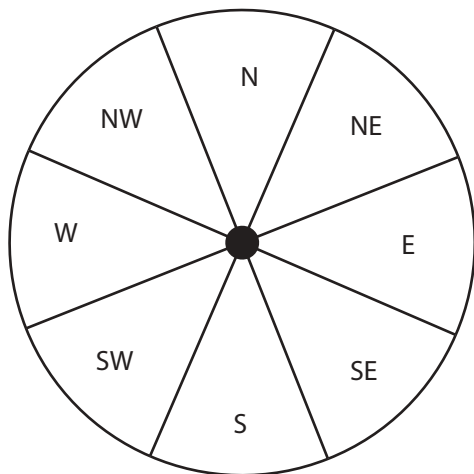
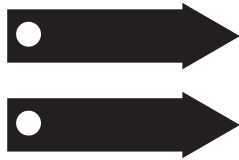

Direction Spinner

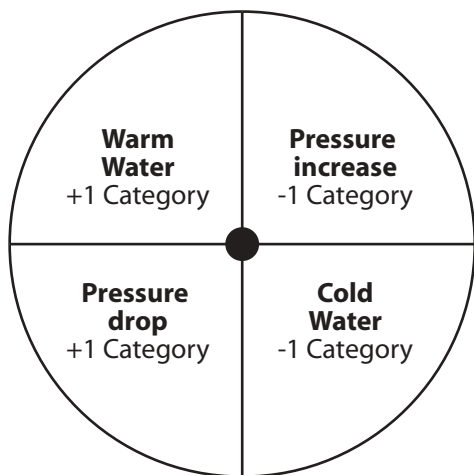

Category Spinner

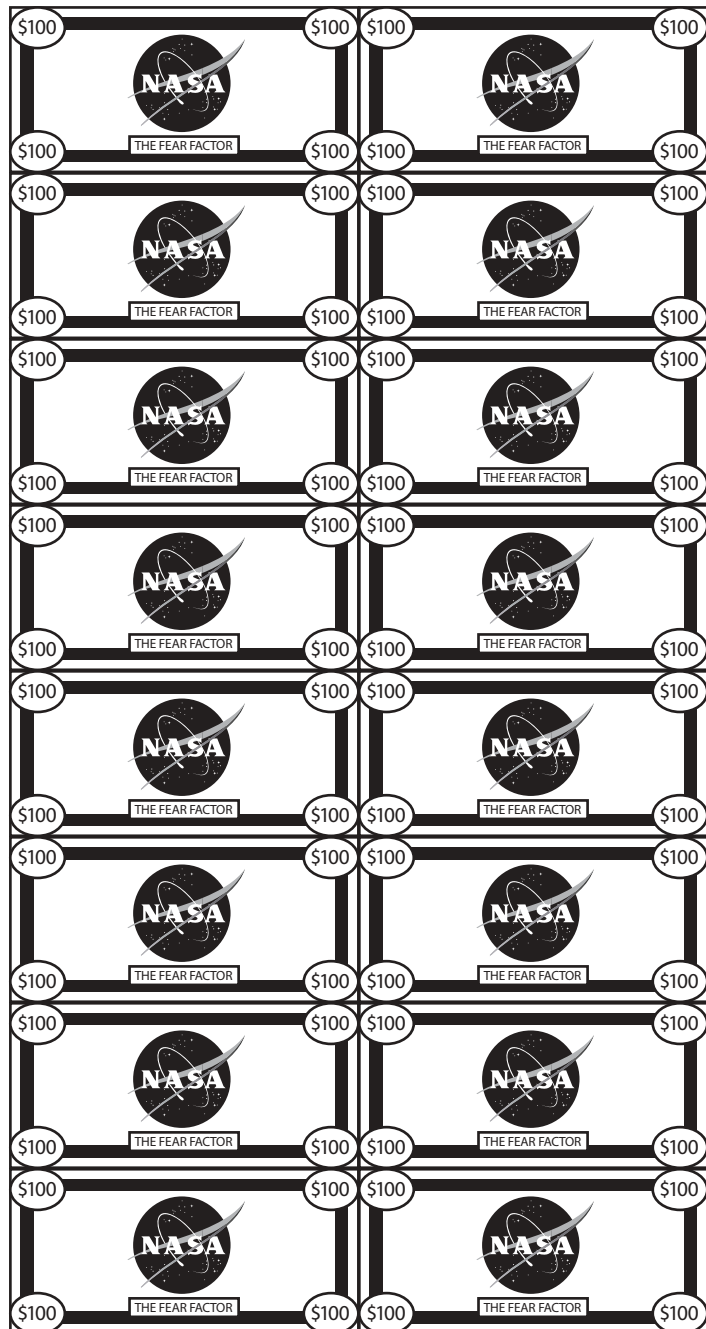

The Fear Factor Game Board

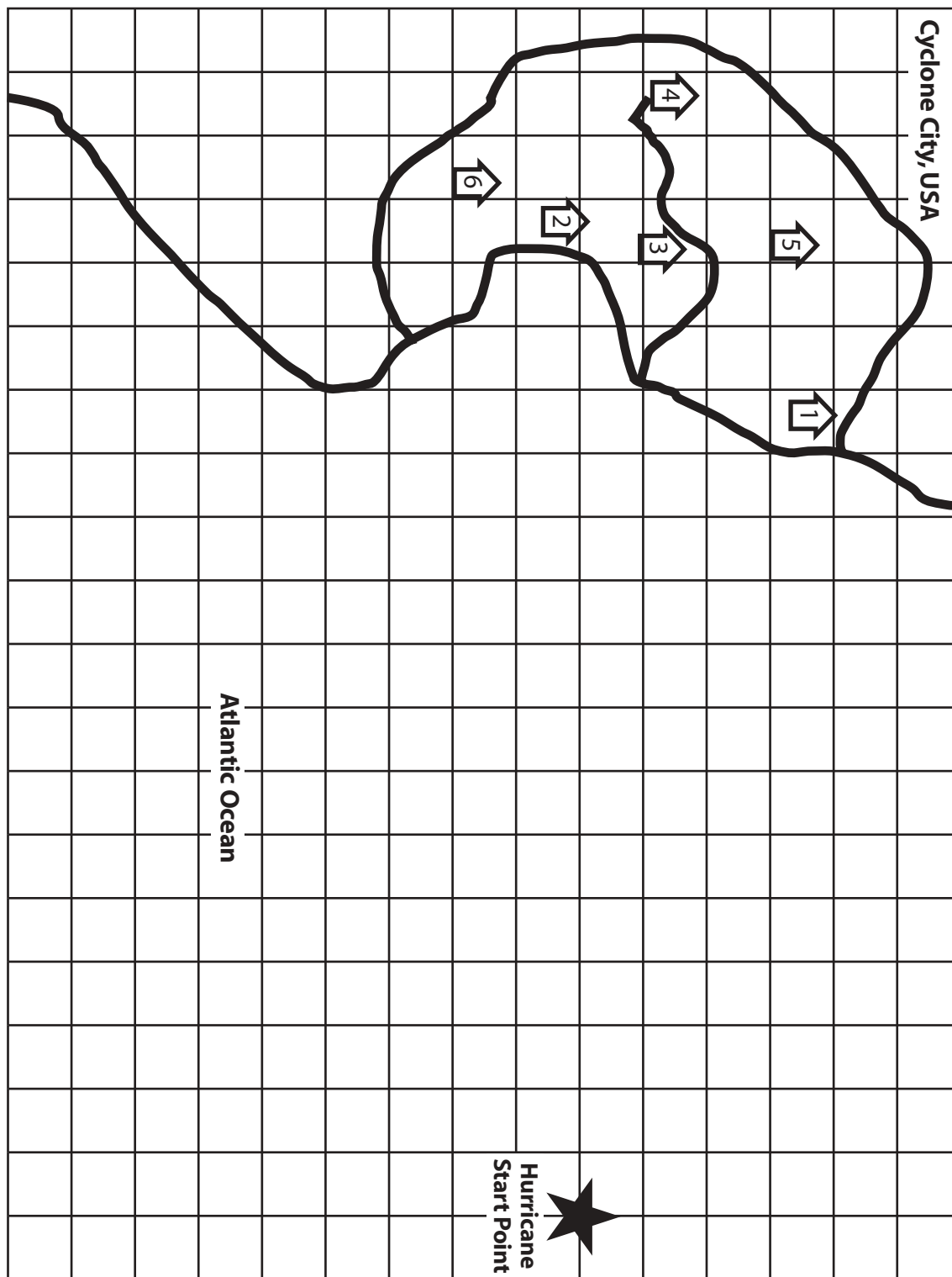

Answer Key

The Probability Factor

1. The die has six faces, but two are covered with the golf tees. That leaves four remaining faces.
2. The chance of any one face landing upright is one in four. If you spin the tester, you have the chance of any one of the four faces landing upright, but only one can, so you have a one in four chance.
3. When the class combines each group's data, the sample data becomes larger, and a pattern may begin to emerge. However, even 500 spins is still a relatively small number of spins in probability.
4. Answers will vary but might include computer models, paths of previous hurricanes that formed in the same area, and current weather data.

Around and Around It Goes.

Where It Will Stop? Do We Know?

1. Most likely, the ball did not always roll in the same path. There are many variables that can affect the path of the ball. Some of the variables may include dirt, small grooves, scratches, or uneven areas on the table or floor. The ball may also have a seam, bump, or dirt on it.
2. By observing the surface of the table or floor and the ball, you are better able to see the variables that would affect its path. For example, if the floor had a deep scratch in it, you would know not to roll the ball across it.
3. Your partner's ball probably did not roll in the same path as your ball. Even though the same variables were present, they were in reverse order.
4. Meteorologists have to consider many variables such as high- and low-pressure systems and their location, the temperature of the water, the path of previous hurricanes, upper atmospheric winds, and so on.

Going Down Anyone?

1. The position of the string did not change when the ruler was lifted.
2. The pull of the Earth's gravity is always downward toward the center of the Earth. No matter at what angle the surface is, gravity pulls objects toward the center; therefore, the positions of the string and paper clip were the same.

3-2-1 Blast Off!

1. The path was a curved line.
2. The marble did not fall straight down because its launching speed pushed it forward.
3. Gravity is the force pulling it downward.
4. The closer an object is to the Earth, the stronger the pull of gravity. A satellite has booster rockets that help it get high enough above the surface of the Earth so that the pull of gravity is not as great.
5. Once a satellite is placed in orbit around the Earth, it will continue to fall in a curved path, but its forward speed is great enough to overcome the pull of gravity. Its forward speed and the pull of gravity keeps a satellite away from the Earth's surface and moving in a curved path.

The Fear Factor

1. Answers will vary but should include the distance of the storm from landfall, strength of the storm, and location of house.
2. No, you cannot accurately predict the path or strength of a hurricane. There are too many variables that enter into the equation, and it is impossible to know each one and how it will affect the storm.
3. Answers will vary. Students should understand that even though the cost to evacuate is high, human life is more valuable than property.
4. The probability is one to eight (1:8).
5. The probability is two to four (2:4) or one to two (1:2).



The NASA "Why?" Files
The Case of the
Phenomenal Weather

Segment 4

In the tree house, the detectives listen to Dr. Textbook as he describes the history of violent hurricanes. Worried that Hurricane Ihabod could cause damage similar to that of past storms, they decide they need to know how to predict landfall. They dial up a NASA "Why?" Files Kids Club classroom in Vero Beach, Florida. Mrs. Srigley's 5th grade class tells them about the "Hurricane Game" and how watches and warnings are issued. Armed with this new information and a new weather update, the tree house detectives visit the National Oceanic and Atmospheric Administration (NOAA) to learn how meteorologists track and predict real hurricanes. The tree house detectives return to Dr. D's to review what they have learned and make their decision about the trip. They think they have finally "predicted" correctly the future path of Hurricane Ihabod and are confident once they have confirmed it.

Objectives

The students will

- understand the risks associated with natural hazards.
- learn how the tracks of past hurricanes can predict the tracks of future hurricanes.
- learn how high and low pressure systems affect hurricanes.

Vocabulary

quadrant - any of the four quarters into which something is divided by two real or imaginary lines that intersect each other at right angles

warning - a warning that sustained winds 64 knots (74 mph or 119 km/hr) or higher associated with a hurricane are expected in a specified coastal area in 24 hours or less. A hurricane warning can remain in

effect when dangerously high water or a combination of dangerously high water and exceptionally high waves continues, even though winds may be less than hurricane force.

watch - An announcement for specific coastal areas that hurricane conditions are possible within 36 hours.

Video Component

Implementation Strategy

The NASA "Why?" Files is designed to enhance and enrich the existing curriculum. Two to three days of class time is suggested for each segment to fully use video, resources, activities, and web site.

Before Viewing

1. Prior to viewing Segment 4 of *The Case of the Phenomenal Weather*, discuss the previous segment to review the problem and what the tree house detectives have learned thus far. Download a copy of the Problem Board from the NASA "Why?" Files web site and have students use it to sort the information learned so far.
2. Review the list of questions and issues that the students created prior to viewing Segment 3 and determine which, if any, were answered in the video or in the students' own research.
3. Revise and correct any misconceptions that may have been dispelled during Segment 3. Use tools located on the web, as was previously mentioned in Segments 1 - 3.
4. Focus Questions - Print the questions from the web site ahead of time for students to copy into their science journals. Encourage students to take notes during the program to answer the questions. An icon will appear when the answer is near.

View Segment 4 of the Video

For optimal educational benefit, view *The Case of the Phenomenal Weather* in 15-minute segments and not in its entirety. If you are viewing a taped copy of the program, you may want to stop the video when the Focus Question icon appears to allow students time to answer the question.

After Viewing

1. At the end of Segment 4, lead students in a discussion of the focus questions for Segment 4.
2. Have students discuss and reflect upon the process that the tree house detectives used to learn about weather and hurricanes. The following instructional tools located in the educator's area of the web site may aid in the discussion: Experimental Inquiry Process Flowchart and/or Scientific Method Flowchart.
3. Choose activities from the educator guide and web site to reinforce concepts discussed in the segment. Pinpoint areas in your curriculum that may need to be reinforced and use activities to aid student understanding in those areas.
4. Wrap up the featured online Problem-Based Learning investigation. Evaluate the students' or teams' final product generated to represent the online PBL investigation. Sample evaluation tools can be found in the Educator's area of the web



site under the main menu topic "Tools."

5. Have students write in their journals what they have learned about weather, hurricanes, and/or

the problem-solving process and share their entry with a partner or the class.

Resources

Books

Brandley, Franklyn M.: *Hurricane Watch*. Harper Trophy, 1985, ISBN: 0064450627.

Lauber, Patricia: *Hurricanes, Earth's Mightiest Storms*. Scholastic Inc., 1996, ISBN: 0590474073.

Watt, Fiona and Francis Wilson: *Usborne Science and Experiments: Weather and Climate*. Usborne Publishing Ltd., 1992, ISBN: 0746006837.

Wright, Russell G.: *Hurricane! An Event-Based Science Nodule*. Addison-Wesley Publishing Company, 1995, ISBN: 0201490943.

Careers

city planners
architects
disaster relief volunteer
Red Cross worker

Web Sites

National Oceanic and Atmospheric Administration

A comprehensive web site with information on weather, satellites, oceans, fisheries, climates, and much more. Educational resources for both the teacher and student are also available.
<http://www.noaa.gov/>

NOAA Weather Radio

The voice of the National Weather Service, NOAA Weather Radio broadcasts National Weather Service watches, warnings, and forecasts and other hazard information 24 hours a day.
<http://tgs55.nws.noaa.gov/nwr/nwrback.htm>

Hurricane Tracking Chart

You can download this gif image of the Atlantic Ocean from Nova Scotia to northern South America and the Gulf of Mexico to track Atlantic hurricanes.
http://www.nhc.noaa.gov/gifs/track_chart.gif

Hurricane Basics

This booklet, in pdf format, provides you with the anatomy of a hurricane and the ingredients that make these killer storms come alive. Graphics help the reader understand how the storms form.
<http://hurricanes.noaa.gov/pdf/hurricanebook.pdf>



Activities and Worksheets

In the Guide

Preparing Posthaste
Learn what to do and how to prepare for an approaching hurricane.55

Decades of Hurricanes
Analyze hurricane data from the 1900's to learn about the frequency of hurricanes. . . .56

Comparing the Statistics
Compare the deadliest and the most expensive hurricanes
to strike the coasts of the U.S.57

NASA Needs Help!
Analyze data from NOAA to help NASA determine where to focus its satellites.59

Lost in a Cyclone
Conduct a "hunt" for weather words lost in a cyclone.62

Just a Little Puzzling
Create your own crossword puzzle using weather words.63

Answer Key
.64

On the Web

The Bermuda High
Learn how a Bermuda high-pressure system will affect a hurricane.

Name that Hurricane
Learn how hurricanes are named and create your own list for possible future hurricanes.



Preparing Posthaste

Research how to prepare for a hurricane using books, magazines, newspapers and web sites and then complete the following scenarios.

Suggested web sites:

<http://www.fema.gov/kids/hurr.htm>

<http://www.usatoday.com/weather/disasters/whhurricane.htm>

You live in a coastal town on the Gulf of Mexico and hurricane season is approaching quickly. You decide that you are going to be smart this year and prepare early for the possibility of a hurricane. Make a list of supplies that you will gather and items you will take care of to prepare for a possible hurricane.

A hurricane has just formed in the Caribbean and it is moving toward the North/Northwest. What steps should you take to prepare for the possible hurricane?

A hurricane watch has just been issued for your town. Make a list of "must do" items and supplies because the hurricane is approaching quickly.

A hurricane warning has now been issued for your town. What is the best course of action to take?



Decades of Hurricanes

Number of Hurricanes by Category to Strike the Mainland U.S. each Decade

DECADE	CATEGORY					ALL CATEGORIES	MAJOR 3,4,5
	1	2	3	4	5		
1900-1909	5	5	4	2	0	16	6
1910-1919	8	3	5	3	0	19	8
1920-1929	6	4	3	2	0	15	5
1930-1939	4	5	6	1	1	17	8
1940-1949	7	8	7	1	0	23	8
1950-1959	8	1	7	2	0	18	9
1960-1969	4	5	3	2	1	15	6
1970-1979	6	2	4	0	0	12	4
1980-1989	9	1	5	1	0	16	6
1990-1996	0	3	3	1	0	7	4
TOTALS							
1900-1996	57	37	47	15	2	158	64

Use the chart above to answer the following questions:

- Which decade had the most hurricanes? _____
- Which decade had the most Category 1 hurricanes? _____
- Which decade had the most major hurricanes? _____
- Which hurricane category is most frequent? _____
- Which hurricane category is the least frequent? _____
- What is the average number of hurricanes per decade? _____
- What is the average number of major hurricanes per decade? _____
- What is the average number of hurricanes per year? _____



Comparing the Statistics

Deadliest Hurricanes of the 20th Century to Strike the U.S.*

* Information was obtained from NOAA
www.nhc.noaa.gov/pastdead.html

Using the chart on the right, shade in the areas affected by each hurricane on the map below. Label with the corresponding rank for each one.

Rank	Hurricane	Year	Category	Deaths
1	TX (Galveston)	1900	4	8,000+
2	FL (Lake Okeechobee)	1928	4	1,836
3	FL (Keys)/S. TX	1919	4	600
4	New England	1938	3	600
5	FL (Keys)	1935	5	408
6	Audrey (SW LA/N TX)	1957	4	390
7	NE U.S.	1944	3	390
8	LA (Grand Isle)	1909	4	350
9	LA (New Orleans)	1915	4	275
10	TX (Galveston)	1915	4	275



1. Which two states had the majority of the deadliest hurricanes? _____
2. How could the hurricane of 1919 strike both the Florida Keys and the southern part of Texas? _____

3. In what part of the century did most of these hurricanes occur? (first 50 years or second 50 years)? _____

Comparing the Statistics

Ten Most Expensive Hurricanes to Strike the U.S. in the 20th Century*

* Information was obtained from NOAA
www.nhc.noaa.gov/pastdead.html

Using the chart on the right, shade in the areas affected by each hurricane on the map below. Use a different color for each million-dollar bracket. For example, use red for \$26 million, orange for \$7 million, yellow for \$3 million, and so on.

Rank	Hurricane	Year	Category	Damage
1	Andrew (SE FL/SE LA)	1992	4	\$ 26,500,000 000
2	Hugo (SC)	1989	4	\$ 7,000,000,000
3	Fran (NC)	1996	3	\$ 3,200,000,000
4	Opal (NW FL/AL)	1995	3	\$ 3,000,000,000
5	Frederic (AL/MS)	1979	3	\$ 2,300,000,000
6	Agnes (NE U.S.)	1972	1	\$ 2,100,000,000
7	Alicia (SE TX/N TX)	1983	3	\$ 2,000,000,000
8	Bob (NC and NE U.S.)	1991	2	\$ 1,500,000,000
9	Juan (LA)	1985	1	\$ 1,500,000,000
10	Camille (MS/AL)	1969	5	\$ 1,420,700,000



- Which two states had the most damage ever by a hurricane? _____
- How could Hurricane Andrew cause damage in Southeast Florida and Southeast Louisiana? _____

- In which half of the century did these costliest hurricanes occur? (first half or second half)? _____
- Explain why the deadliest hurricanes occurred in a different part of the century than the most costly. _____



NASA Needs Help!

Problem

To determine the best location on Earth for satellites to focus on for better detection of hurricane formation.

Materials

hurricane data table (p. 60)
hurricane tracking chart (p. 61)
5 different colored pencils

Procedure

1. NASA needs your help with a new satellite that it is developing. You and your team must determine which areas within the Atlantic Ocean are the best areas for the new satellite to focus on to watch for the formation of hurricanes. NOAA has collected the data (listed on p. 60).
2. Using a different color for each year, color the map key.
3. Plot the hurricanes' origins on a hurricane tracking map using the appropriate color for each year.
4. Once the origins are plotted, the map will resemble a scatter plot. Look carefully at the visual display of hurricane origins to determine where to focus the satellites.
5. Each area must be no larger than five degrees of latitude by five degrees of longitude.
6. As you choose the areas where the satellites will focus, think of several reasons for your choices and write them in your science journal.
7. Mark the sites on the hurricane tracking map and present your reasons for your decision to the class.

NASA Needs Help! – Hurricane Data Table

Year	Hurricane	Latitude North	Longitude West
1995	Allison	19.3	85.7
	Erin	22.3	73.2
	Felix	15.5	36.4
	Humberto	13.7	34.3
	Iris	13.3	50.6
	Luis	11.6	29.0
	Marilyn	11.8	52.7
	Noel	12.1	40.6
	Opal	21.1	88.5
	Roxanne	16.5	83.1
	Tanya	26.2	57.9
1996	Bertha	11.0	39.0
	Cesar	12.1	68.1
	Dolly	18.2	83.0
	Edouard	13.2	31.6
	Fran	14.6	44.9
	Hortense	16.1	64.5
	Isidore	11.7	34.2
	Lili	19.6	83.5
	Marco	13.8	78.5
1997	Bill	31.8 6	8.9
	Danny	28.3	91.4
	Erika	12.3	47.1
1998	Bonnie	17.3	57.3
	Danielle	14.2	37.9
	Earl	22.4	93.8
	Georges	10.6	31.3
	Ivan	16.0	32.6
	Jeanne	11.0	19.4

Year	Hurricane	Latitude North	Longitude West
1998	Karl	33.2	60.7
	Lisa	14.2	47.1
	Mitch	11.6	77.9
	Nicole	27.9	29.1
1999	Bret	19.8	94.7
	Cindy	13.6	26.6
	Dennis	22.4	70.0
	Floyd	15.3	48.2
	Gert	14.2	31.9
	Irene	18.5	83.4
	Jose	10.9	52.8
	Lenny	16.4	79.9
2000	Alberto	12.0	22.3
	Debby	13.3	46.8
	Florence	30.4	72.2
	Gordon	22.5	86.7
	Isaac	12.3	25.9
	Joyce	11.5	31.9
	Keith	17.4	84.8
	Michael	29.9	71.8
2001	Erin	13.2	37.5
	Felix	18.6	47.7
	Gabrielle	25.3	84.9
	Humberto	27.9	66.3
	Iris	14.8	64.5
	Karen	34.9	65.3
	Michelle	15.8	83.1
	Noel	37.8	50.3
	Olga	29.5	49.8



NASA Needs Help!

NASA HURRICANE TRACKING Map



Key

- 1995
- 1996
- 1997
- 1998
- 1999
- 2000
- 2001

WATCH/WARNING

Watch = Hurricane or Tropical Storm conditions expected within 36 hours
 Warning = Hurricane or Tropical Storm conditions expected within 24 hours

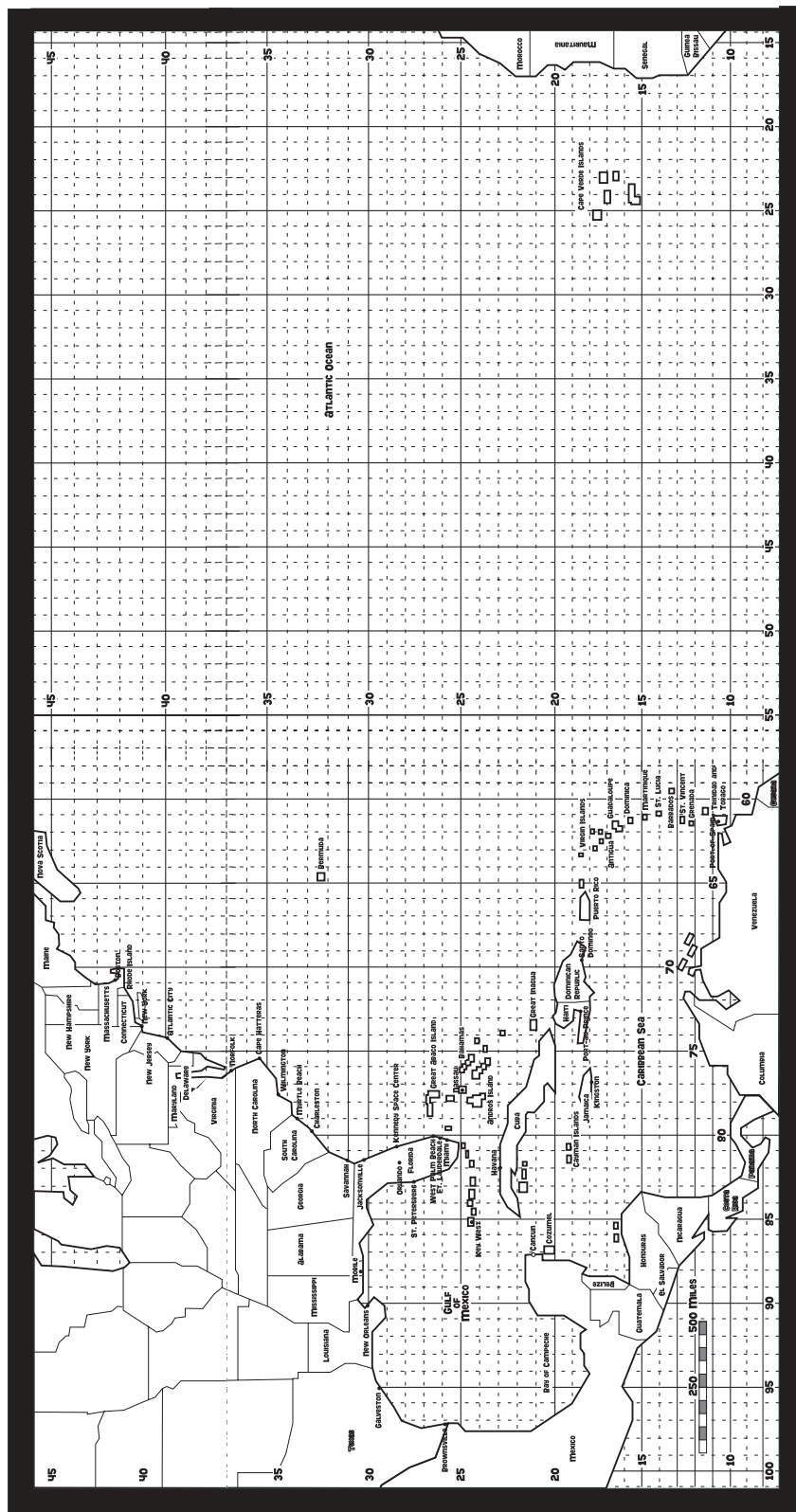

Lost in a Cyclone

H S T T I T E O N O D A D R O T
 U S A E D K C Y P H H D M I H R
 R T T T S U T T E E P N R A E O
 R L A R E U F G R A V I T Y W P
 I F E F A L I H C S T W I C M I
 C R P Z D T L E E S U L U M U C
 A O C R B N U I N K W E R D N A
 N P R H O T A S T E O W A V E L
 E A I I H B C V D E M H R F T D
 I V C M O S A U T S R T L F S E
 L R W I O P T B M U O N W R F P
 I E A L G I E B I G K A E J L R
 T T M E T E O R O L O G I S T E
 R A C A T E G O R Y I O S G G S
 E W L O R M G O G U S T J T G S
 G E O S T A T I O N A R Y B D I
 E H R O R M G O G A S W J S G O
 P R E D I C T S I L O I R O C N

Word Bank

hurricane
eye
tratus
predict

probability
geostationary
water vapor
wind

gravity
tropical depression
category

tornado
cumulus
satellite

percent
latitude
Coriolis

meteorologist
wave
Andrew



Just a Little Puzzling

Create a crossword puzzle with the following terms and the grid below.

Vocabulary

hurricane
longitude
meteorologist
landfall

tropics
polar orbiting
probability
water vapor

tornado
latitude
Coriolis effect
NOAA

LIDAR
cirrus
prediction
eye wall

satellite
GIFTS
gravity
category I

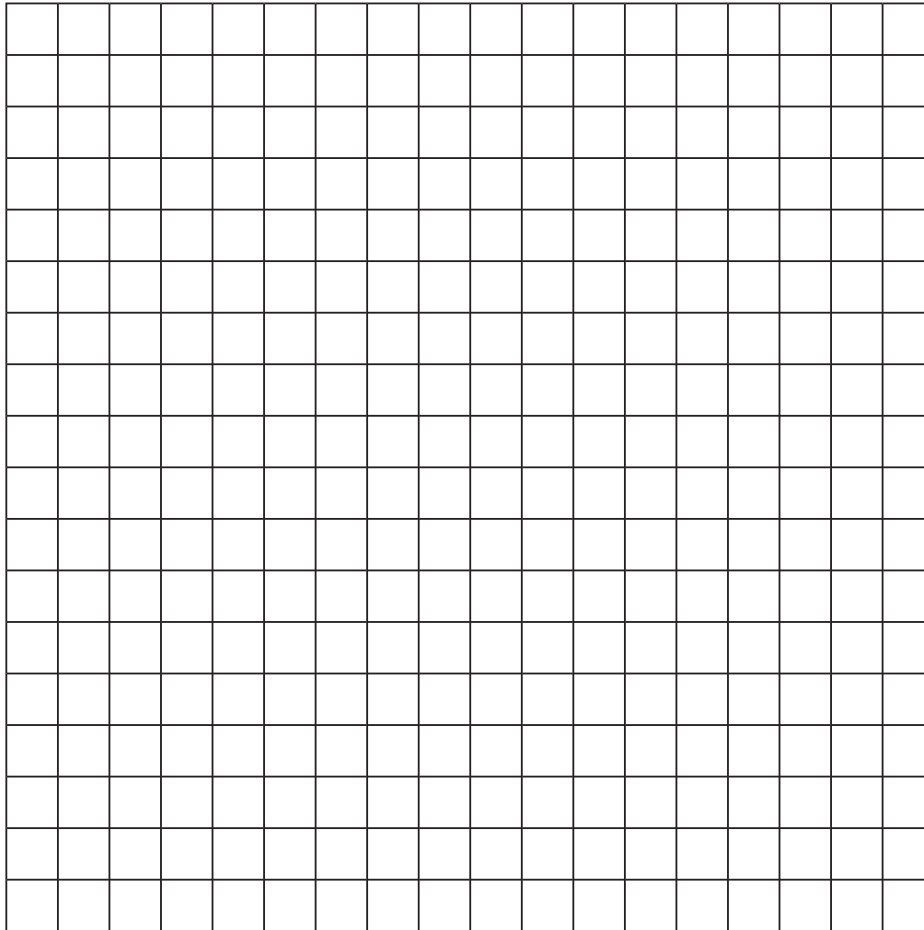

Down

- 1. _____
- 2. _____
- 3. _____
- 4. _____
- 5. _____
- 6. _____
- 7. _____
- 8. _____
- 9. _____
- 10. _____
- 11. _____
- 12. _____
- 13. _____

Across

- 1. _____
- 2. _____
- 3. _____
- 4. _____
- 5. _____
- 6. _____
- 7. _____
- 8. _____
- 9. _____
- 10. _____
- 11. _____
- 12. _____
- 13. _____



Answer Key

Preparing Posthaste

Answers will vary.

Decades of Hurricanes

1. 1940-1949
2. 1980-1989
3. 1950-1959
4. Category 1
5. Category 5
6. The average number of hurricanes per decade is approximately 17. Since 1990-1996 is not a complete decade, subtract seven from 158 for 151 total hurricanes. Divide 151 by nine for the number of complete decades and you get 16.77.
7. The average number of major hurricanes (Categories 3, 4, and 5) is approximately 7. Subtract 4 from 64 and divide the answer by 9 for an answer of 6.66.
8. The average number of hurricanes per year is approximately two. Divide 158 by 97 (number of years) for an answer of 1.63.

Comparing the Statistics

1. Texas and Florida
2. The hurricane of 1919 passed through the Florida Keys and entered the Gulf of Mexico where it strengthened and continued in a path to strike southern Texas.
3. First 50 years.
4. Florida and Louisiana
5. Hurricane Andrew first struck the coast of southeast Florida and then continued until it entered the Gulf of Mexico where it continued in a path to strike southeast Louisiana.
6. Second half of the century
7. The deadliest hurricanes occurred in the first half of the century when we did not have radar, satellites, and other technology that now warns us of approaching hurricanes long before they strike land.

Lost in a Cyclone

H S T T I T E O N O D A D R O T
 U S A E D K C Y P H H D M I H R
 R T T T S U T T E E P N R A E O
 R L A R E U F G R A V I T Y W P
 I F E F A L I H C S T W I C M I
 C R P Z D T L E E S U L U M U C
 A O C R B N U I N K W E R D N A
 N P R H O T A S T E O W A V E L
 E A I I H B C V D E M H R F T D
 I V C M O S A U T S R T L F S E
 L R W I O P T B M U O N W R F P
 I E A L G I E B I G K A E J L R
 T T M E T E O R O L O G I S T E
 R A C A T E G O R Y I O S G G S
 E W L O R M G O G U S T J T G S
 G E O S T A T I O N A R Y B D I
 E H R O R M G O G A S W J S G O
 P R E D I C T S I L O I R O C N

